

# Tie rod cylinder ISO 6431, Series 167

## 1670310000

General series information  
AVENTICS Series 167 Tie-rod cylinder

- The AVENTICS Series 167 is a tie rod cylinder according ISO 6431 and offers the highest robustness for tough environment.

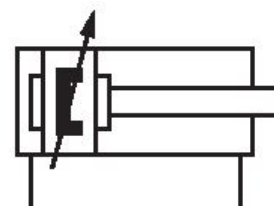

### Technical data

Industry	Industrial
Standards	ISO 6431
Piston Ø	32 mm
Stroke	100 mm
Ports	G 1/8
Functional principle	Double-acting
Cushioning	Pneumatic adjustable cushioning
Magnetic piston	Piston with magnet
Environmental requirements	Industry standard
Piston rod	single
Scraper	Standard Industry Scraper
Pressure for determining piston forces	[[8] bar]
Retracting piston force	420 N
Extracting piston force	480 N

Min. ambient temperature	-20 °C
Max. ambient temperature	75 °C
Working pressure min.	2 bar
Working pressure max	10 bar
Piston rod thread	M10x1,25
Cushioning length	13.5 mm
Weight 0 mm stroke	0.45 kg
Weight +10 mm stroke	0.021 kg
Stroke max.	1500 mm
Medium	Compressed air
Min. medium temperature	-20 °C
Max. medium temperature	75 °C
Max. particle size	50 µm
Oil content of compressed air min.	0 mg/m <sup>3</sup>
Oil content of compressed air max.	5 mg/m <sup>3</sup>

## Material

Piston rod	Stainless Steel
Seal material	Acrylonitrile butadiene rubber
Material, front cover	Aluminum
Cylinder tube	Aluminum
End cover	Aluminum
Part No.	1670310000

## Technical information

Ø25 mm is not according to ISO 6431

The pressure dew point must be at least 15 °C less than ambient and medium temperature and may not exceed 3 °C.

The oil content of compressed air must remain constant during the life cycle.

Use only the approved oils from AVENTICS. Further information can be found in the “Technical information” document (available in <https://www.emerson.com/en-us/support>).

## Dimensions

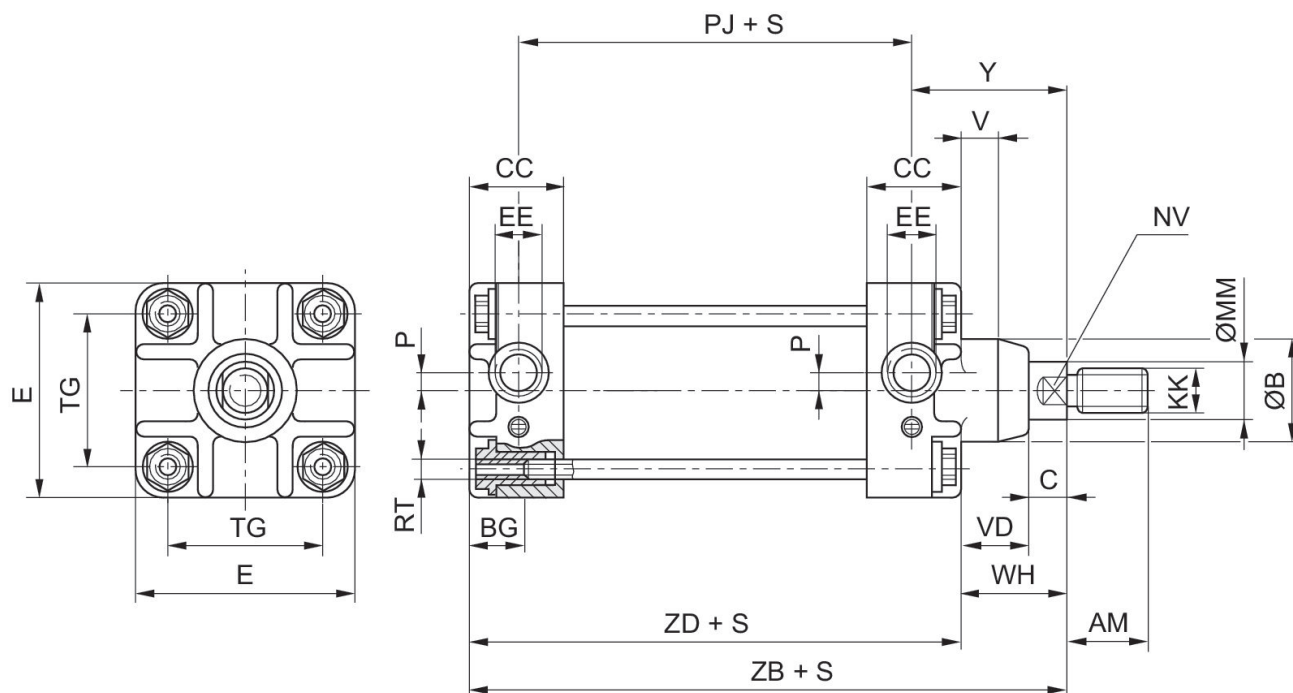

Piston Ø	AM	Ø B h12	BG	C	CC	E	EE	KK	Ø MM
25	22	23	12	8	20,0	40	G 1/8	M10x1,25	12
32	22	25	12	10	27,5	47	G 1/8	M10x1,25	12
40	24	35	15	13	30,0	56	G 1/4	M12x1,25	16
50	32	40	15	15	30,0	63	G 1/4	M16x1,5	20
63	32	40	19	14	34,0	81	G 3/8	M16x1,5	20
80	40	48	19	16	36,0	95	G 3/8	M20x1,5	25
100	40	55	23	16	40,0	115	G 1/2	M20x1,5	25

Piston Ø	NV	P	PJ	RT	TG	V	VD	WH	Y
25	10	-	58	M5	27	-	16	24	31
32	10	4	65	M5	32	5	16	26	41
40	13	4	69	M6	40	5	20	33	48
50	17	4	72	M6	46	6	23	38	54
63	17	6	79	M8	59	6	27	41	58
80	22	9	86	M8	73	8	32	48	67
100	22	12	100	M10	90	8	37	53	70

Piston Ø	ZB	ZD	stroke tolerance
25	98 ±1,2	74	+2/-1
32	120 ±1,2	94	+2/-0
40	132 ±1,2	99	+2/-0
50	142 ±1,2	104	+2/-0
63	154 ±1,4	113	+2,5/-0

Piston Ø	ZB	ZD	stroke tolerance
80	172 ±1,4	124	+2,5/-0
100	187 ±1,4	134	+2,5/-0

## Cushioning diagram

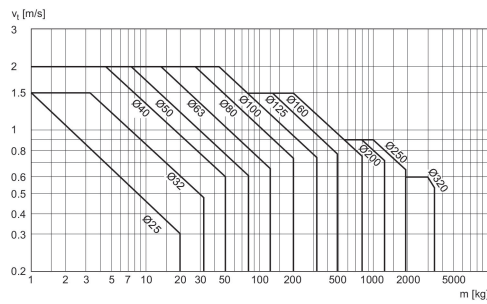

V = velocity [m/s]  
m = mass

## Overview drawing



NOTE: This overview drawing is only for orientation to indicate where the various accessory parts can be fastened to the cylinder. The illustration has been simplified for this purpose. It is thus not possible to derive the dimensions from this overview.