

T-connector

1823381006

Valve
accessories

2024-08-13



Technical data

Industry	Industrial
Clearance (LW)	8 mm
Delivery unit	10 piece
Weight	0.007 kg

Material

Housing material	Polyoxymethylene
Part No.	1823381006

T-connector

1823381006

Valve
accessories

2024-08-13

Dimensions

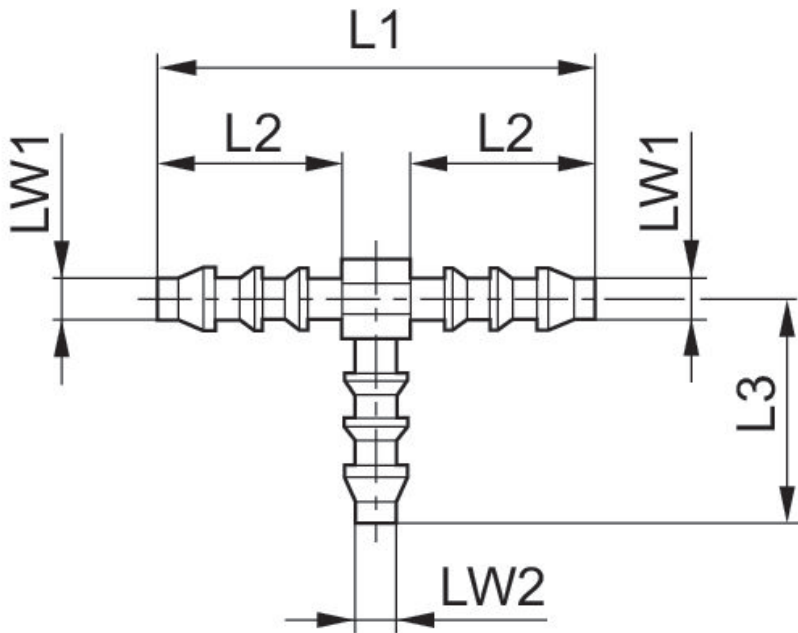

Dimensions in mm

Part No.	LW	LW2	L1	L2	L3
1823381015	3 mm	3 mm	25	10	13
1823381004	4 mm	4 mm	35	14.5	20
1823381009	4 mm	6 mm	35	14.5	24
1823381012	6 mm	4 mm	49	20.5	21
1823381007	6 mm	6 mm	50	20.5	26
1823381013	8 mm	4 mm	56	23	22
1823381014	8 mm	6 mm	56	23	28
1823381010	8 mm	8 mm	58	–	30
1823381006	8 mm	13 mm	58	22.5	36
1823381032	10 mm	6 mm	62	25	31
1823381033	10 mm	8 mm	62	25.5	31
1823381034	10 mm	10 mm	62	25	33
1823381005	13 mm	8 mm	70	–	34
1823381035	13 mm	10 mm	70	–	36
1823381011	13 mm	13 mm	73	–	39
1823381008	19 mm	19 mm	87	–	46