

Distribution block

1823391383

AVENTICS
Distributors
and
distributor
strips

AVENTICS Distributors and distributor strips

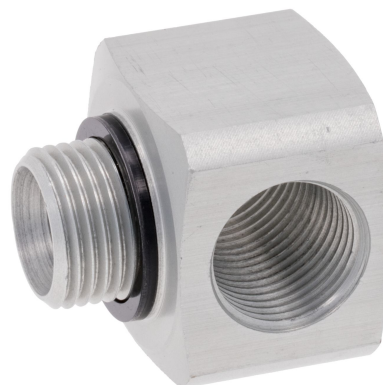

Technical data

Industry	Industrial
Type	Distributor 2x
Port G	G 1/2
Working pressure min.	0 bar
Working pressure max	16 bar
Min. ambient temperature	-10 °C
Max. ambient temperature	70 °C
Delivery unit	2 piece
Weight	0.075 kg

Material

Housing material	Aluminum
Surface housing	anodized
Seal material	Polyvinyl chloride
Surface seals	hard
Part No.	1823391383

Distribution block

1823391383

AVENTICS
Distributors
and
distributor
strips

Dimensions

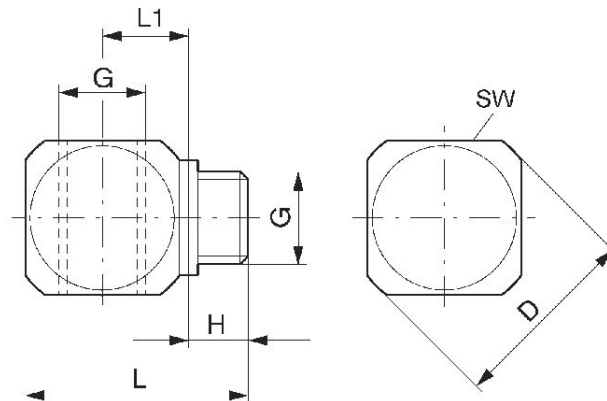

Part No.	G	D	H	L	L1	SW
1823391096	M5	12.5	5	15	5.5	10
1823391097	G 1/8	20	7	24	9	15
1823391098	G 1/4	28.5	10	30	11	22
1823391099	G 3/8	35	10	33	12.5	27
1823391383	G 1/2	46	12	41.5	16	36