

Silencers, series S11

8240040000

General series information
AVENTICS Series S11 Silencers

- AVENTICS Series S11 Silencers offers a broad range of silencers even in Metal or plastic to reduce the noise when Pneumatic products come to exhaust.

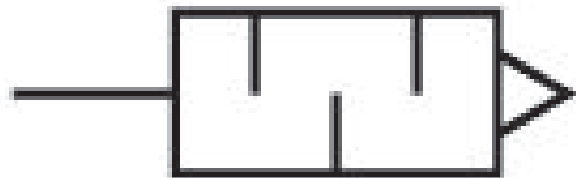

Technical data

Industry	Industrial
Medium	Compressed air
Working pressure min.	0 bar
Working pressure max	10 bar
Min. ambient temperature	-25 °C
Max. ambient temperature	80 °C
Compressed air connection	Ø 4
Compressed air connection type	pin bushing
Sound pressure level	72 dB
Nominal flow Qn	366 l/min
Delivery unit	5 piece
Weight	0.004 kg

Material

Silencer material
Material push-in fitting
Part No.

Sintered bronze
Brass
8240040000

Dimensions

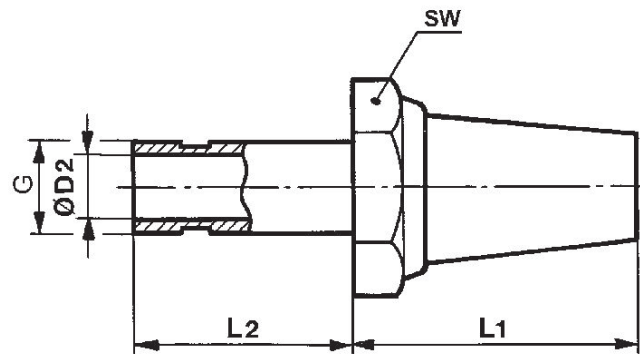

Part No.	Port G	Ø D2	L1	L2	SW
8240040000	Ø 4	2.5	16	17	10
8240060000	Ø 6	4	18	19	13
8240080000	Ø 8	6	25	19	17

Sound pressure level measured at 6 bar at 1 m distance

Flow diagram 8240080000

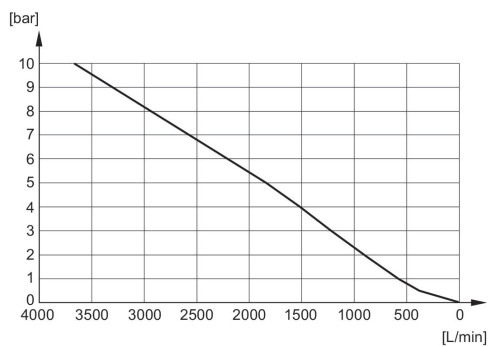

Flow diagram 8240060000

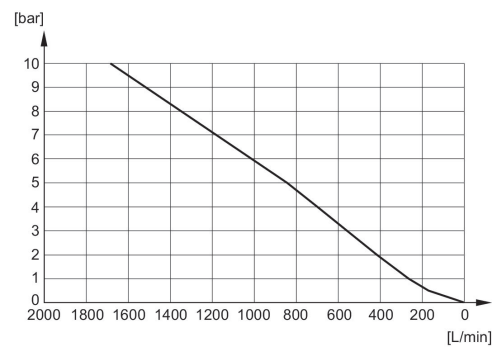

Flow diagram
8240040000

