

Check-choke valve, Series 344

2023-11-01

2992344125

AVENTICS Series 344 Check-Choke valve

The AVENTICS Series 344 Stainless steel check choke valves are designed to be acid resistant can be used in even with compressed air and oil and up to 120°C.

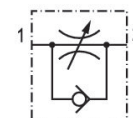

Technical data

Industry	Industrial
Port 1	G 3/8
Nominal flow Qn 2 to 1	1960 l/min
Flow conductance C	2.77 l/(s*bar)
Note	acid-proof
Medium	Compressed air Oil
Min. working pressure	0 bar
Max. working pressure	16 bar
Min. ambient temperature	-20 °C
Max. ambient temperature	120 °C
Min. medium temperature	-20 °C
Max. medium temperature	120 °C
Weight	0.55 kg

Material

Housing material	Stainless Steel
Surface housing	acid-proof
Seal material	Fluorocautchouc
Part No.	2992344125

Technical information

The min. control pressure must be adhered to, since otherwise faulty switching and valve failure may result!

The pressure dew point must be at least 15 °C less than ambient and medium temperature and may not exceed 3 °C.

The oil content of compressed air must remain constant during the life cycle.

Use only the approved oils from AVENTICS. Further information can be found in the “Technical information” document (available in <https://www.emerson.com/en-us/support>).

Dimensions

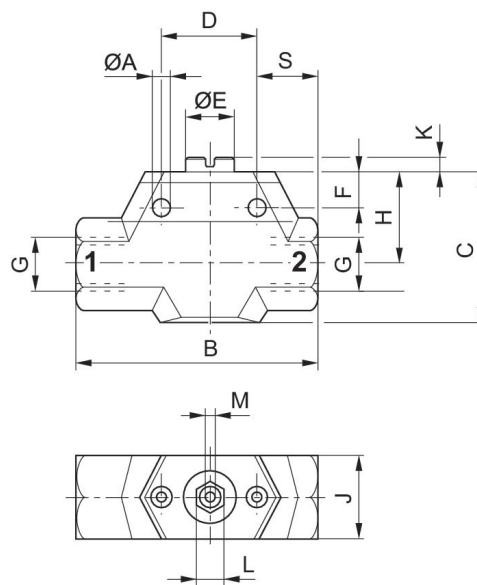

Part No.	Port G	B	C	D	E	F	#A	H	J
2992344110	G 1/8	46	29	20	9	9	4.5	19	17
2992344120	G 1/4	61	38	20	9	11	5.5	23	20
2992344125	G 3/8	80	55	30	14	13.5	5.5	31	27
2992344130	G 1/2	104	65	40	18	16.5	6.5	39.5	34
2992344140	G 3/4	142	87	50	28	21.5	8.5	51.5	42
2992344150	G 1	167	103	60	34	26	8.5	62	52

Part No.	K	L	M	S
2992344110	1.5	–	1.5	12
2992344120	3.5	–	1.5	15
2992344125	9	–	1.5	19
2992344130	4	10	–	24
2992344140	9	10	–	30
2992344150	10.5	10	–	32