

3/2-way stop valve, Series SC01

R412010526

General series information
AVENTICS Series SC01 Stop valves

- AVENTICS Series SC01 Stop valves are available even in 2/2 or 3/2 construction. SC01 stop valves control flow direction and support a diverse range of system requirements. Our ball valves are both reliable and robust when it comes to service and are available in various configurations and options.

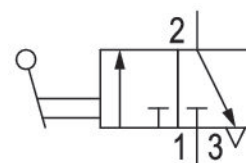
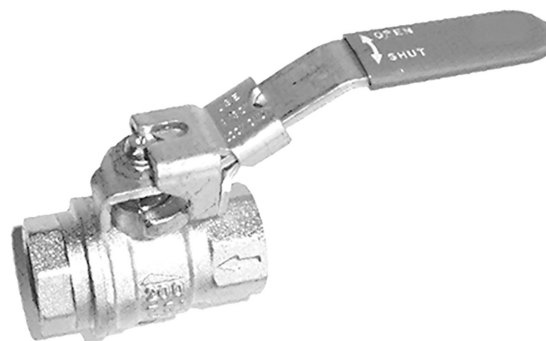

Technical data

Industry	Industrial
Type	Ball Valve
Switching principle	3/2
Medium	Compressed air
Compressed air connection 1	G 1/8
Compressed air connection type 1	Internal thread
Compressed air connection 2	G 1/8
Compressed air connection type 2	Internal thread
Min. ambient temperature	-10 °C
Max. ambient temperature	100 °C
Min. medium temperature	-10 °C
Max. medium temperature	100 °C
Working pressure min.	0 bar
Working pressure max	14 bar
Weight	0.1 kg

Material

Housing material	Brass
Housing material	nickel-plated
Seal material	Polytetrafluorethylene
Material hand lever	Steel, chrome-plated
Surface hand lever	Plastic sheathing, blue
Part No.	R412010526

Dimensions

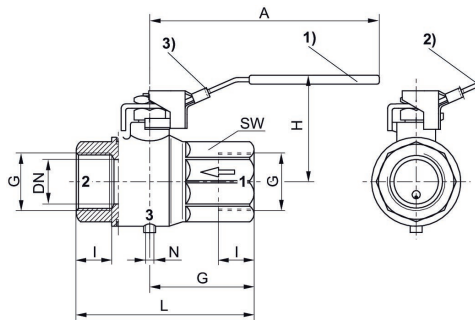

- 1) Open 2) Closed
3) Fitting for padlock (max. bracket \varnothing 7 mm)

Note: Can only be locked when closed!
Padlock not included in the scope of delivery.

Part No.	Port G	DN	A	G	H	I	L	N	SW
R412010526	G 1/8	8	95.5	22.5	47	8	45	M5	20
R412010527	G 1/4	8	95.5	22.5	47	12	45	M5	20
R412010528	G 3/8	10	95.5	22.5	47	12	45	M5	20
R412010529	G 1/2	15	95.5	29.5	51.5	15.5	59	M5	25
R412010530	G 3/4	20	116	32	59	17	64	M5	31
R412010531	G 1	25	116	40.5	63	21	81	M5	40