

3/2-directional valve, electrically operated, Series 652

G652A5S630A00F1

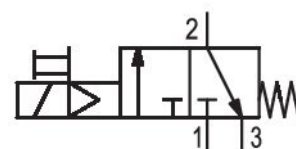

Technical data

Industry	Industrial
Activation	Electrically
Nominal flow Qn	3750 l/min
Compressed air connection	G 3/8
Working pressure min.	3.8 bar
Working pressure max	10 bar
Certificates	ATEX optional
ATEX	ATEX optional
Connection type	Pipe connection
Parts	3/2-directional valve
Type	Poppet valve
Min. ambient temperature	-10 °C
Max. ambient temperature	50 °C

Min. medium temperature	-10 °C
Max. medium temperature	50 °C
Medium	Compressed air Neutral gases
Nominal flow Qn 1 to 2	3750 l/min
Nominal flow Qn 2 to 3	4300 l/min
Operating voltage	24 V
Connection type operating voltage	DC
Weight	0.44 kg

Material

Housing material	Aluminum
Seal material	Nitrile butadiene rubber
Part No.	G652A5S630A00F1

Technical information

The min. control pressure must be adhered to, since otherwise faulty switching and valve failure may result!

The pressure dew point must be at least 15 °C less than ambient and medium temperature and may not exceed 3 °C.

The oil content of compressed air must remain constant during the life cycle.

Use only the approved oils from AVENTICS. Further information can be found in the "Technical information" document (available in <https://www.emerson.com/en-us/support>).

Dimensions

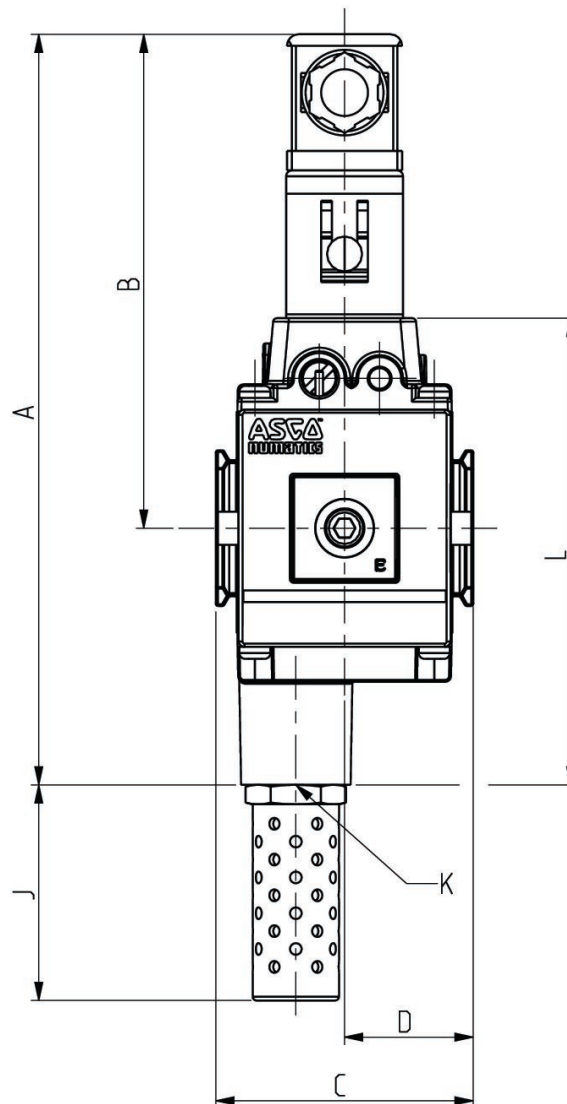
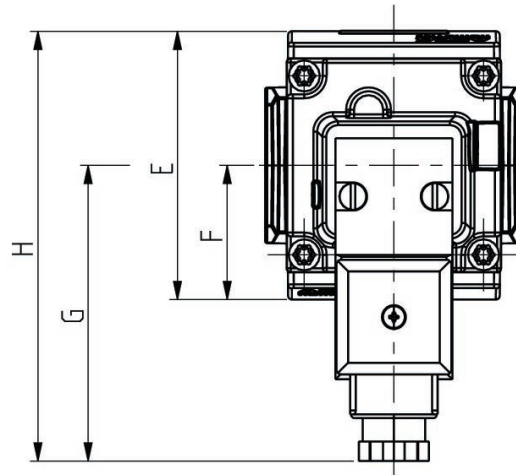

Series	652
A	193
B	127
C	66
D	33
E	69
F	34,5
G	76
H	110,5
J	57
K	G 1/2
L	120

Accessories overview

