

Filling unit, electrically operated, Series 651

G651A6S620A00F1

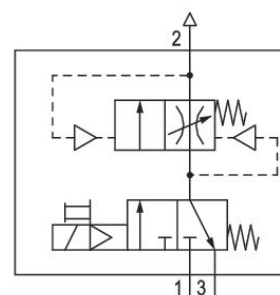

Technical data

Industry	Industrial
Activation	Electrically
Nominal flow Qn	1000 l/min
Compressed air connection	G 1/4
Working pressure min.	3.8 bar
Working pressure max.	10 bar
Certificates	ATEX optional
Connection type	Pipe connection
Parts	Filling valve
Min. ambient temperature	-10 °C
Max. ambient temperature	50 °C
Min. medium temperature	-10 °C

Max. medium temperature	50 °C
Medium	Compressed air Neutral gases
Nominal flow Qn 1 to 2	1000 l/min
Nominal flow Qn 2 to 3	1120 l/min
Operating voltage	24 V
Connection type operating voltage	DC
Weight	0.39 kg

Material

Housing material	Aluminum
Seal material	Nitrile butadiene rubber
Part No.	G651A6S620A00F1

Technical information

If P1 supply flow is restricted on valves with internal pilot supply, temporary leakage can occur.

The min. control pressure must be adhered to, since otherwise faulty switching and valve failure may result!

The pressure dew point must be at least 15 °C less than ambient and medium temperature and may not exceed 3 °C.

The oil content of compressed air must remain constant during the life cycle.

Use only the approved oils from AVENTICS. Further information can be found in the "Technical information" document (available in <https://www.emerson.com/en-us/support>).

Dimensions

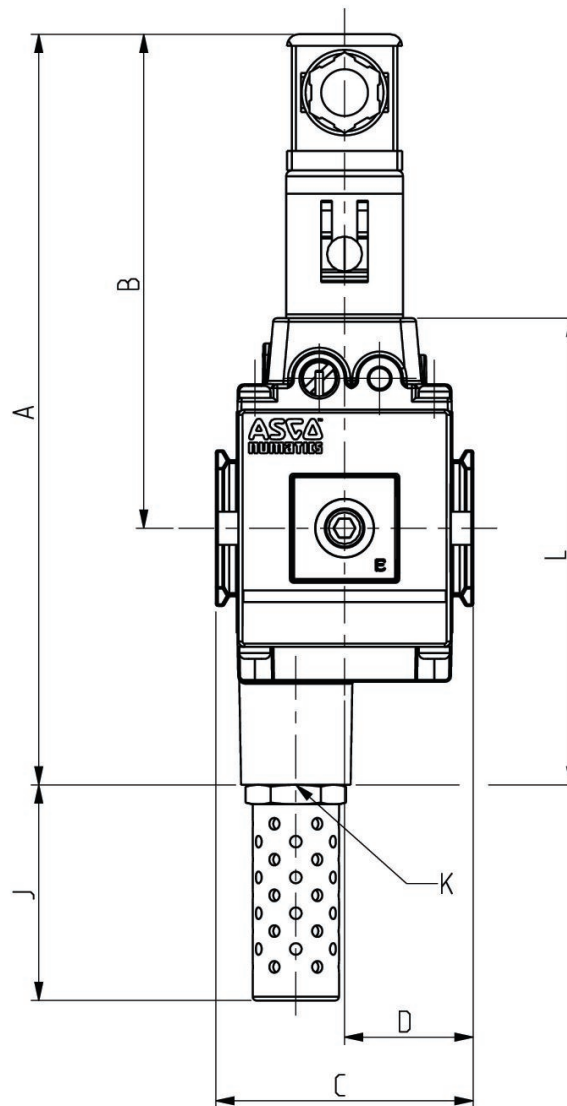
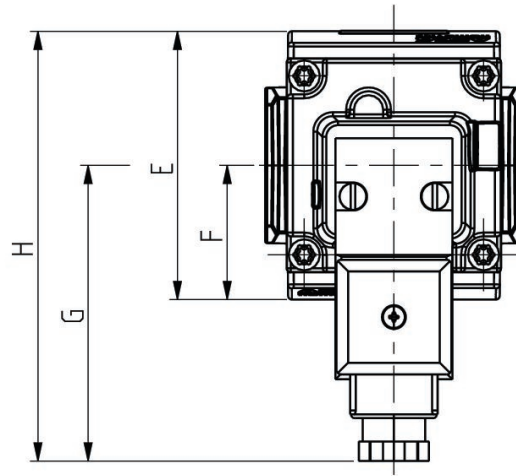

Series	651
A	170
B	116
C	50
D	25
E	58
F	29
G	72
H	101
J	34,5
K	G 1/4
L	97

Accessories overview

