

51900008

Series 519

The AVENTICS Series 519 is a line of air-operated mini-spool valves that are ideal for piloting pneumatic cylinders. The valves are suitable for automotive, case packing, packaging, and tire manufacturing applications.

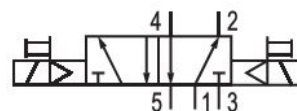

Technical data

Industry	Industrial
Activation	Electrically
Valve type	Spool valve
Switching principle	5/2, double solenoid
Actuating control	Double Solenoid
Sealing principle	Soft seal
Connection type	Pipe connection
Manual override	without detent
Compressed air connection input	M5
Compressed air connection output	M5
Nominal flow Qn	175 l/min
Min. working pressure	1.5 bar
Max. working pressure	8 bar
Min. control pressure	1.5 bar
Max. control pressure	8 bar

5/2-directional valve, Series 519

2023-11-13

51900008

Electrical connection type	Plug
Electrical connection size	EN 175301-803, form C
Connector standard	EN 175301-803
Protection class with connection	IP65
Operational voltage	230 V AC
Operational voltage AC at 50 Hz	230 V

Pilot	Internal
Pilot valve width	15 mm
Switch-on power AC 50 Hz	2 VA

Duty cycle	100 %
Typ. switch-on time	20 ms

Min. ambient temperature	5 °C
Max. ambient temperature	50 °C
Medium	Compressed air
Min. oil content of compressed air	0 mg/m ³
Max. oil content of compressed air	5 mg/m ³
Max. particle size	5 µm

Mounting screws	M2.5 with slot
Weight	0.135 kg

Material

Housing material	Aluminum, anodized
Seal material	Nitrile butadiene rubber
Material threaded bushing	Aluminum
Material front plate	Polyoxymethylene
Part No.	51900008

Technical information

The min. control pressure must be adhered to, since otherwise faulty switching and valve failure may result!

The pressure dew point must be at least 15 °C less than ambient and medium temperature and may not exceed 3 °C.

The oil content of compressed air must remain constant during the life cycle.

Use only the approved oils from AVENTICS. Further information can be found in the "Technical information" document (available in <https://www.emerson.com/en-us/support>).

5/2-directional valve, Series 519

2023-11-13

51900008

Dimensions

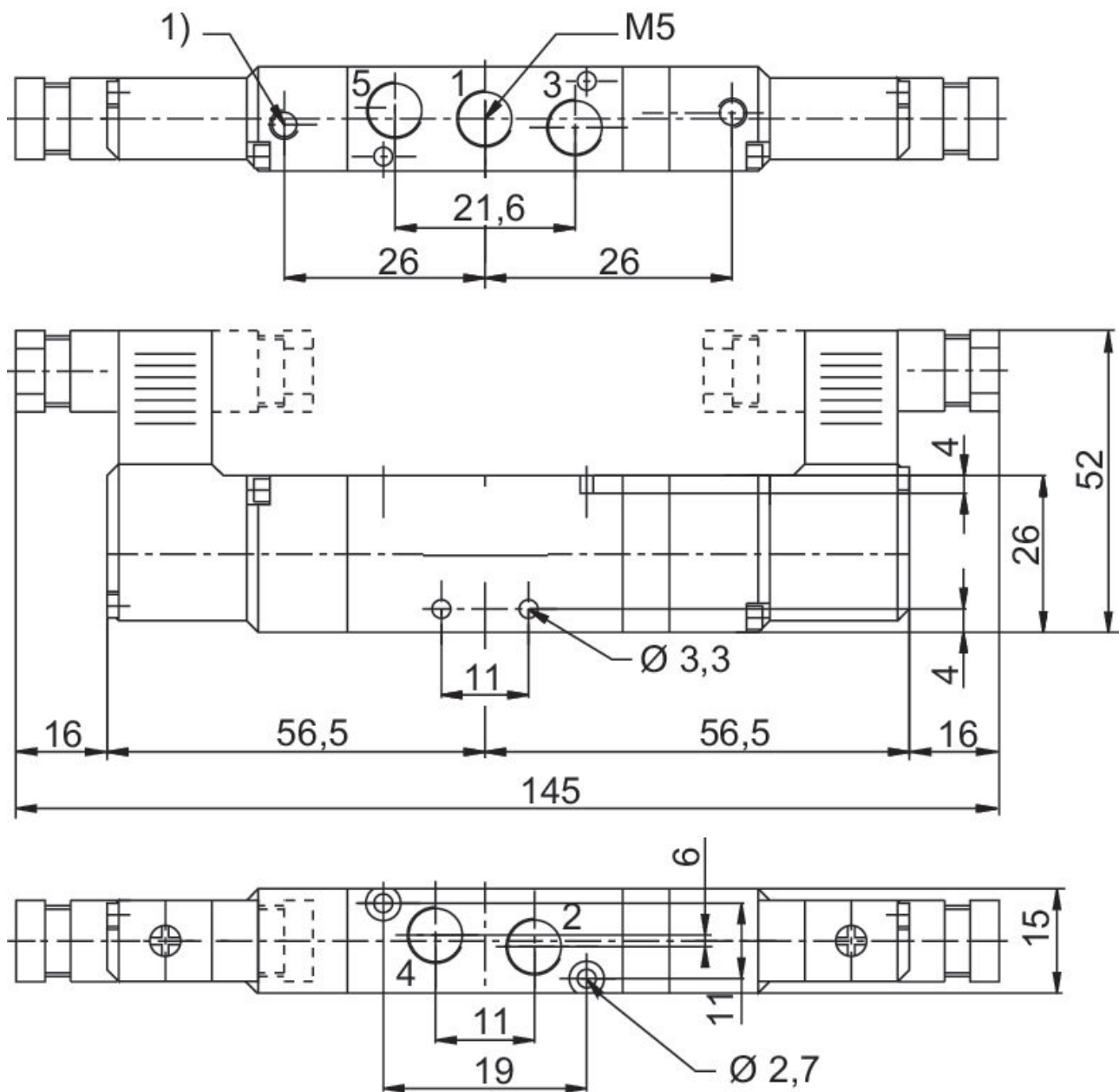

1) Pilot Exhaust