

3/2-shut-off valve, mechanically operated, Series 651

G651A3M02011100

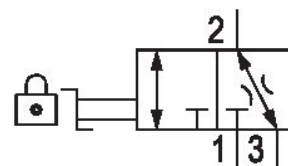

Technical data

Industry	Industrial
Activation	Mechanical
Nominal flow Qn	4720 l/min
Compressed air connection	G 1/4
Working pressure min.	0 bar
Working pressure max	16 bar
Certificates	ATEX optional
Parts	Shut-off valve
Lock type	for padlocks
Connection type	Pipe connection
Silencer	with silencer
Min. ambient temperature	-10 °C
Max. ambient temperature	50 °C

Min. medium temperature	-10 °C
Max. medium temperature	50 °C
Medium	Compressed air Neutral gases
Compressed air connection standard	according to ISO 228-1
Nominal flow Qn 1 to 2	4720 l/min
Nominal flow Qn 2 to 3	250 l/min
Weight	0.26 kg
Housing material	Aluminum
Seal material	Nitrile butadiene rubber
Silencer material	metal
Part No.	G651A3M02011100

Technical information

The min. control pressure must be adhered to, since otherwise faulty switching and valve failure may result!

The pressure dew point must be at least 15 °C less than ambient and medium temperature and may not exceed 3 °C.

The oil content of compressed air must remain constant during the life cycle.

Use only the approved oils from AVENTICS. Further information can be found in the "Technical information" document (available in <https://www.emerson.com/en-us/support>).

Dimensions

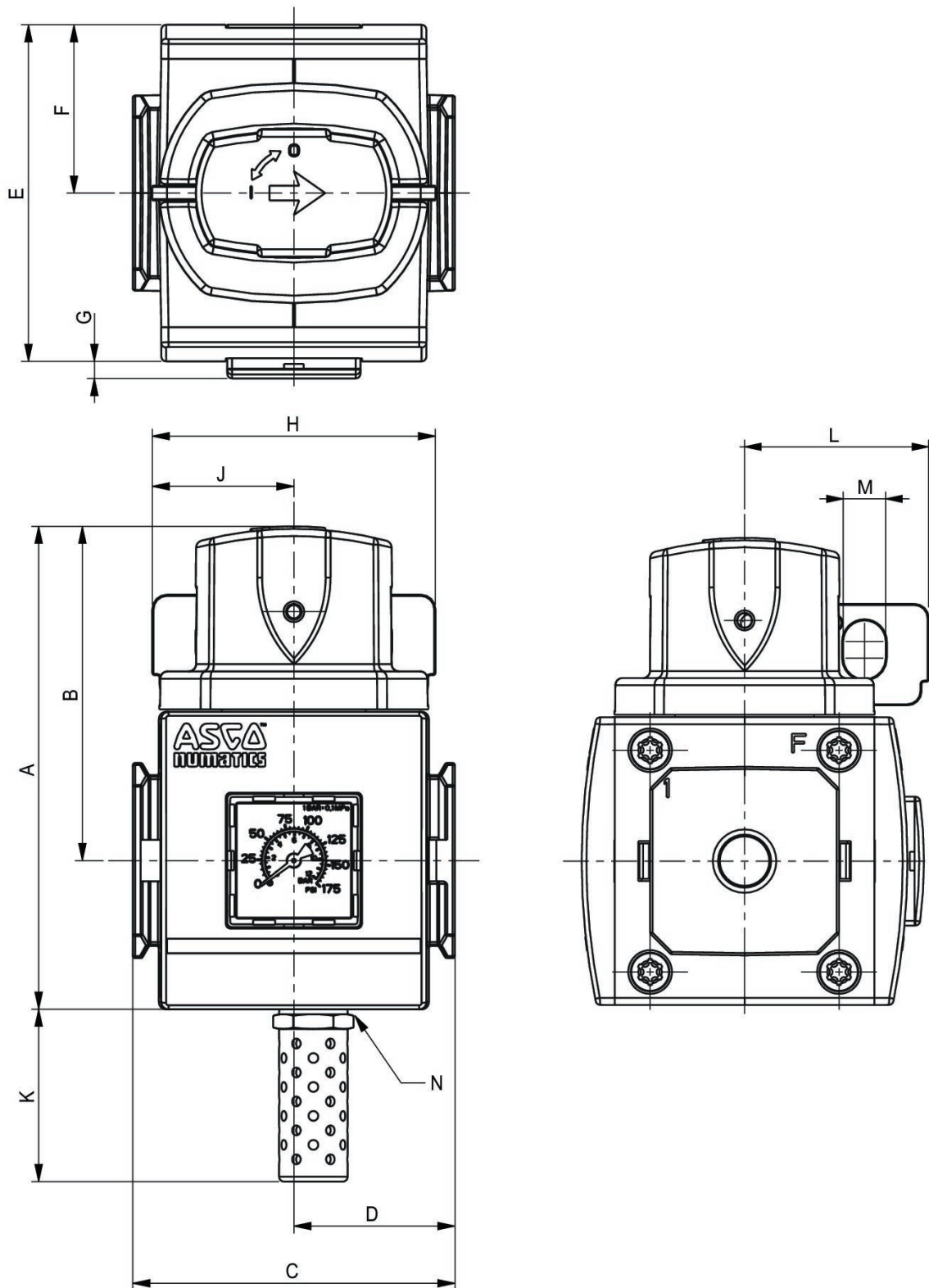

Series	651
A	90,5
B	65,5
C	50
D	25
E	58
F	29
G	4,4
H	57,8
J	28,9
K	35,5
L	38
M	9
N	G 1/4

Accessories overview

