

- fine thread
- Piston rod: external thread
- Single-acting, retracted without pressure

AVENTICS Series 102 Diaphragm type cylinder

The AVENTICS Series 102 is cost-efficient solution to generate high forces for press application for example.



Technical data

Industry	Industrial
Piston Ø	80 mm
Stroke	40 mm
Ports	G 1/4
Functional principle	Single-acting, retracted without pressure
Piston rod thread - type	External thread
Piston rod thread	M12x1,25
Pressure for determining piston forces	6 bar
Extracting piston force	3000 N
Min. ambient temperature	-20 °C
Max. ambient temperature	70 °C
Min. working pressure	2 bar
Max. working pressure	8 bar
Min. spring force	100 N
Max. spring force	300 N
Weight	2.8 kg
Medium	Compressed air
Min. medium temperature	-20 °C
Max. medium temperature	70 °C

Diaphragm-type cylinder, Series 102

Series 102

1020100000

2024-06-10

Max. particle size	50 µm
Min. oil content of compressed air	0 mg/m ³
Max. oil content of compressed air	5 mg/m ³

Material

Piston rod	Steel, chrome-plated
Seal material	Acrylonitrile butadiene rubber
Material, front cover	Steel, chrome-plated
Cylinder tube	Steel, chrome-plated
Part No.	1020100000

Technical information

Diaphragm actuator strokes are tolerance-dependent.

Tolerance at 40 mm, 50 mm, 80 mm stroke: ± 3 mm

The pressure dew point must be at least 15 °C less than ambient and medium temperature and may not exceed 3 °C.

The oil content of compressed air must remain constant during the life cycle.

Use only the approved oils from AVENTICS. Further information can be found in the “Technical information” document (available in <https://www.emerson.com/en-us/support>).

Diaphragm-type cylinder, Series 102

1020100000

Series 102

2024-06-10

Dimensions

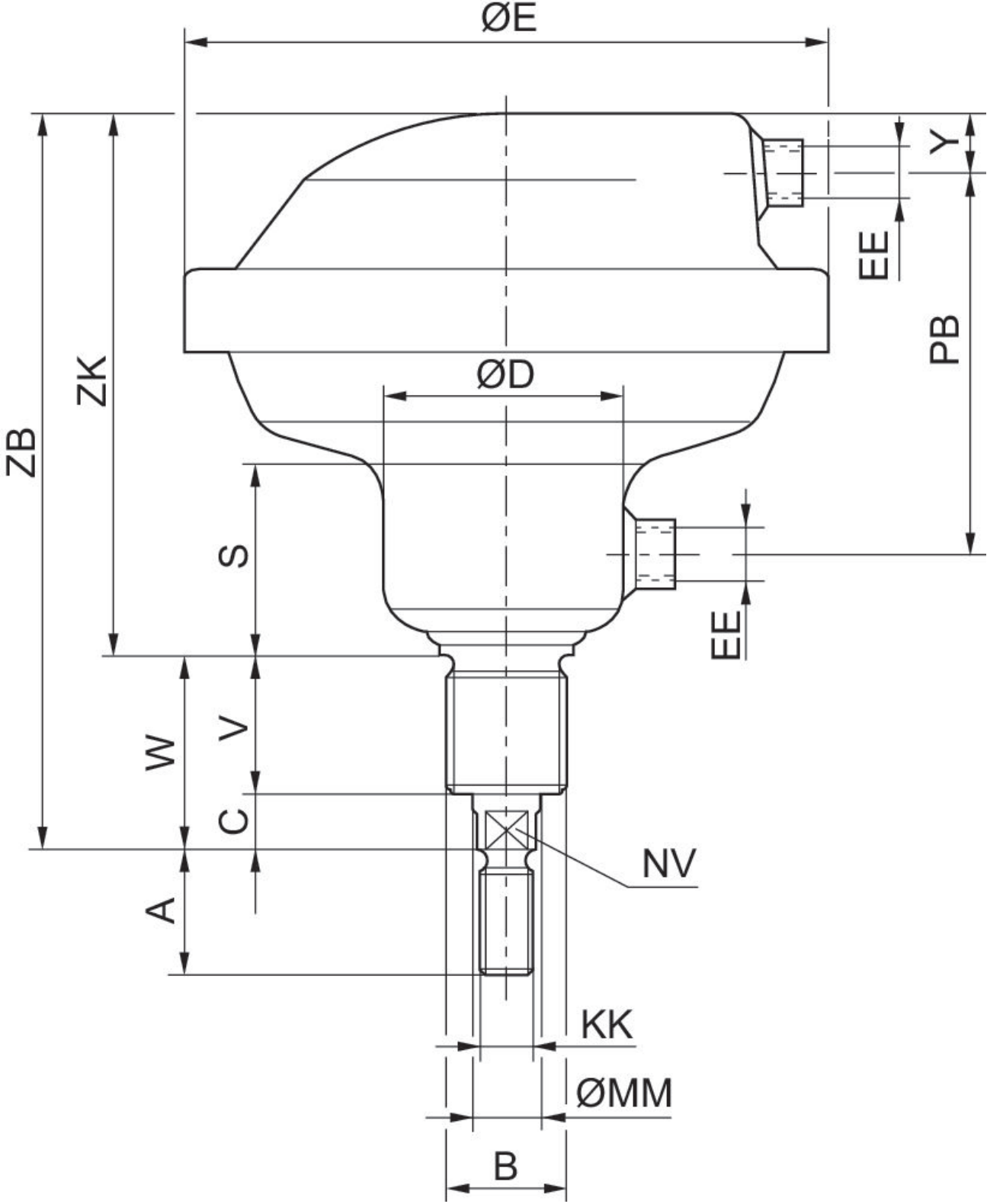

Diaphragm-type cylinder, Series 102

Series 102

1020100000

2024-06-10

Part No.	Piston Ø	A	B	C	D	E	S	V	W
1020100000	80	24	M24x2	14	55	150	48	38	52
1020200000	113	32	M36x3	20	71	195	55	38	58
1020300000	160	40	M36x3	20	88	261	58	45	65

Part No.	Piston Ø	Y	EE	KK	MM	NV	PB	ZB	ZK
1020100000	80	15	G 1/4	M12x1.25	16	13	90	183	131
1020200000	113	15	G 1/4	M16x1.5	20	17	107	212	154
1020300000	160	26	G1/2	M20x1.5	25	22	117	243	178

Diaphragm-type cylinder, Series 102

Series 102

1020100000

2024-06-10

Overview drawing

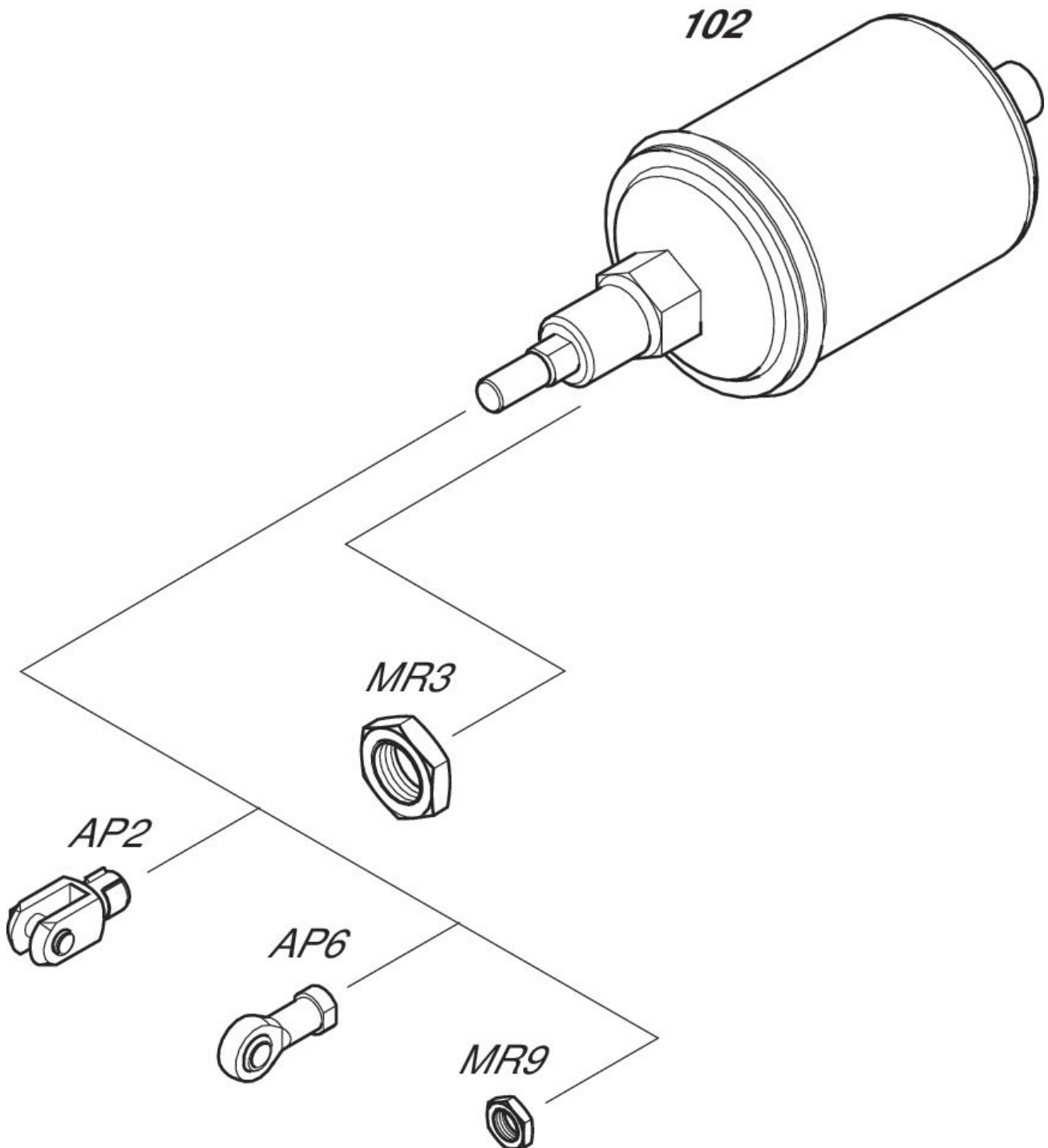

NOTE: This overview drawing is only for orientation to indicate where the various accessory parts can be fastened to the cylinder. The illustration has been simplified for this purpose. It is thus not possible to derive the dimensions from this overview.