

Rod clevis, Series AP2

1827009942

Rod
clevises

2023-10-05

AVENTICS Rod clevises

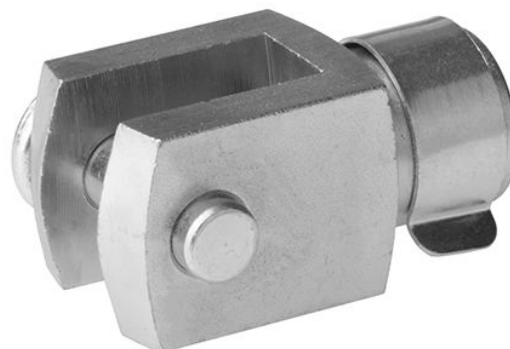

Technical data

Industry

Industrial

Thread size

M20x1,5

Material

Housing material

Steel, chrome-plated

Surface housing

galvanized

Part No.

1827009942

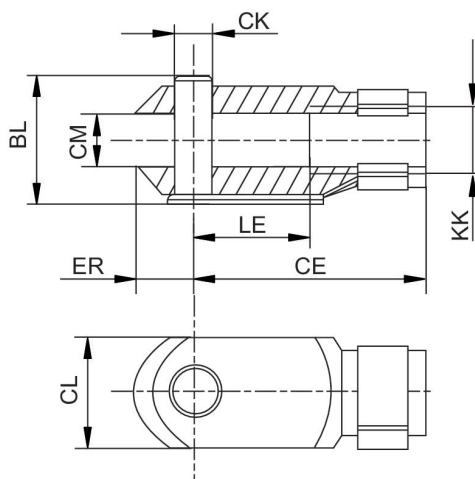

Rod clevis, Series AP2

1827009942

Rod
clevises

2023-10-05

KK	Part No.	BL	CE	ØCK e11	CL	CM	ER	LE
M10x1,5	1827009940	28	36	8	22	11	9	16
M16x1,5	1827009941	44	51	12	26	18	13	25
M20x1,5	1827009942	53	63	16	34	22	17	33
M27x2	1827009943	76	85	20	44	30	20	30
M36x2	7472ZZ1444	93	115	25	56	40	25	40