

Pressure regulator, Series AS1-RGS

R412014639

General series information Series AS1

- The AVENTICS Series AS1 is a modular, versatile maintenance unit for universal application. This Series offers compact dimensions, is highly efficient, lightweight and easy-to-use. The AVENTICS Series AS guarantees reliability, safety, and efficiency with a simplified assembly and maintenance efforts.

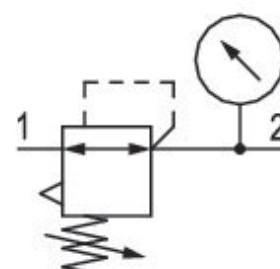

Technical data

Industry	Industrial
Function	Standard pressure regulator
Parts	Pressure regulator
Pressure gauge	pressure gauge in hand wheel
Mounting orientation	Any
Regulator type	Diaphragm-type pressure regulator
Port	G 1/4
Nominal flow Qn	1000 l/min
Regulation range min.	0.2 bar
Regulation range max.	4 bar
Working pressure min.	0.2 bar
Working pressure max	12 bar

Min. ambient temperature	-10 °C
Max. ambient temperature	50 °C
Air supply	left
Activation	Manual
Regulator function	with relieving air exhaust
Regulator type	Can be assembled into blocks
Lock type	not lockable
Medium	Compressed air Neutral gases
Weight	0.239 kg

Material

Housing material	Polyamide
Material front plate	Acrylonitrile butadiene styrene
Seal material	Acrylonitrile butadiene rubber
Part No.	R412014639

Technical information

The pressure dew point must be at least 15 °C less than ambient and medium temperature and may not exceed 3 °C.

Relieving exhaust (≤ 0.3 bar over set pressure)

With rear exhaust (>3 bar)

Nominal flow Q_n with secondary pressure $p_2 = 6$ bar at $\Delta p = 1$ bar

Panel nut included in scope of delivery

Dimensions in mm

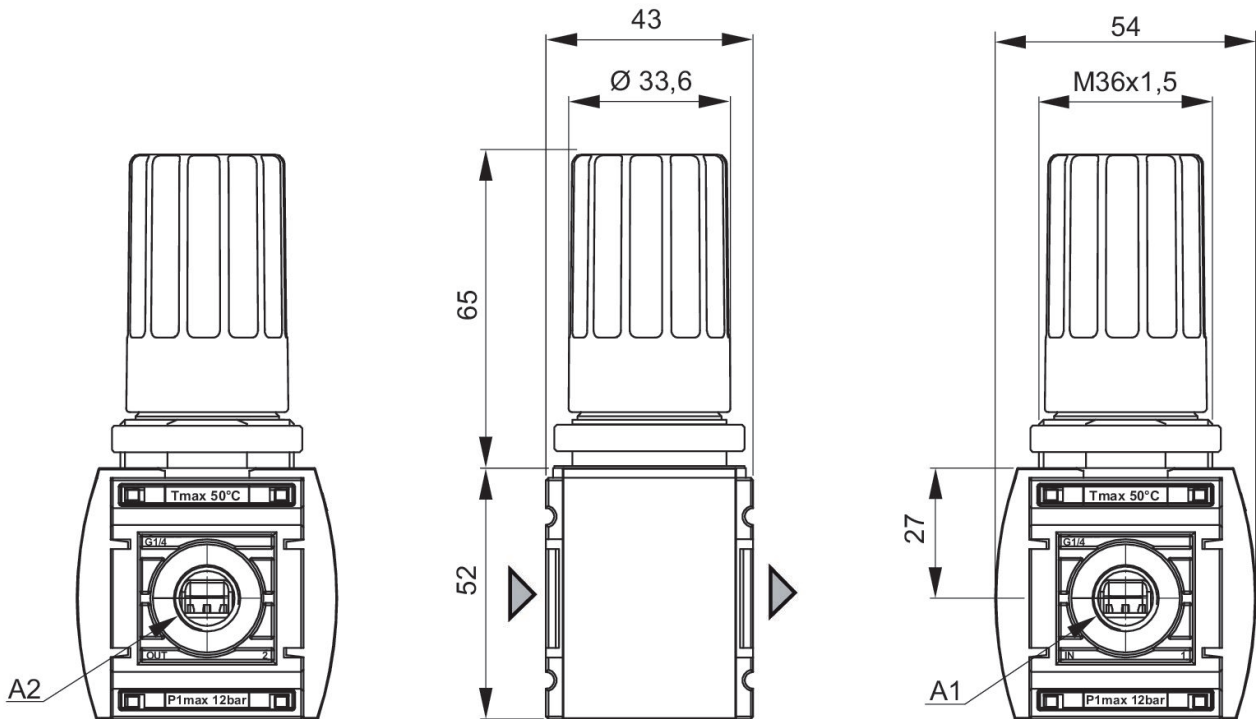

A1 = input
A2 = output
Panel nut included in scope of delivery

Pressure characteristics curve

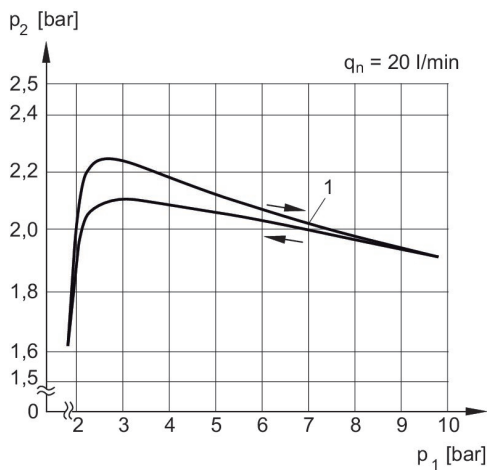

p_1 = Working pressure
 p_2 = Secondary pressure
 q_n = Nominal flow
1) = Starting point

Flow rate characteristic, $p_2 = 0,05 - 7$ bar

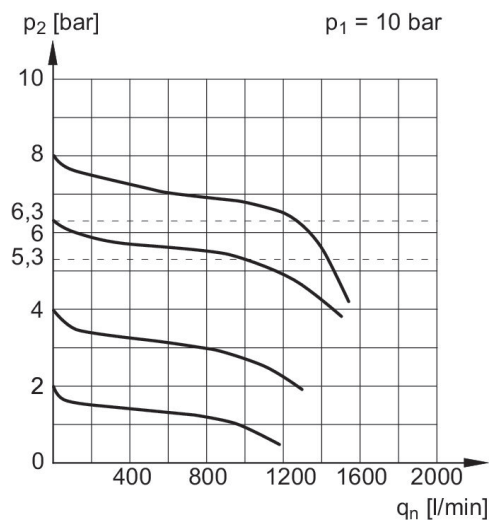

p_1 = Working pressure
 p_2 = Secondary pressure
 q_n = Nominal flow

Accessories overview

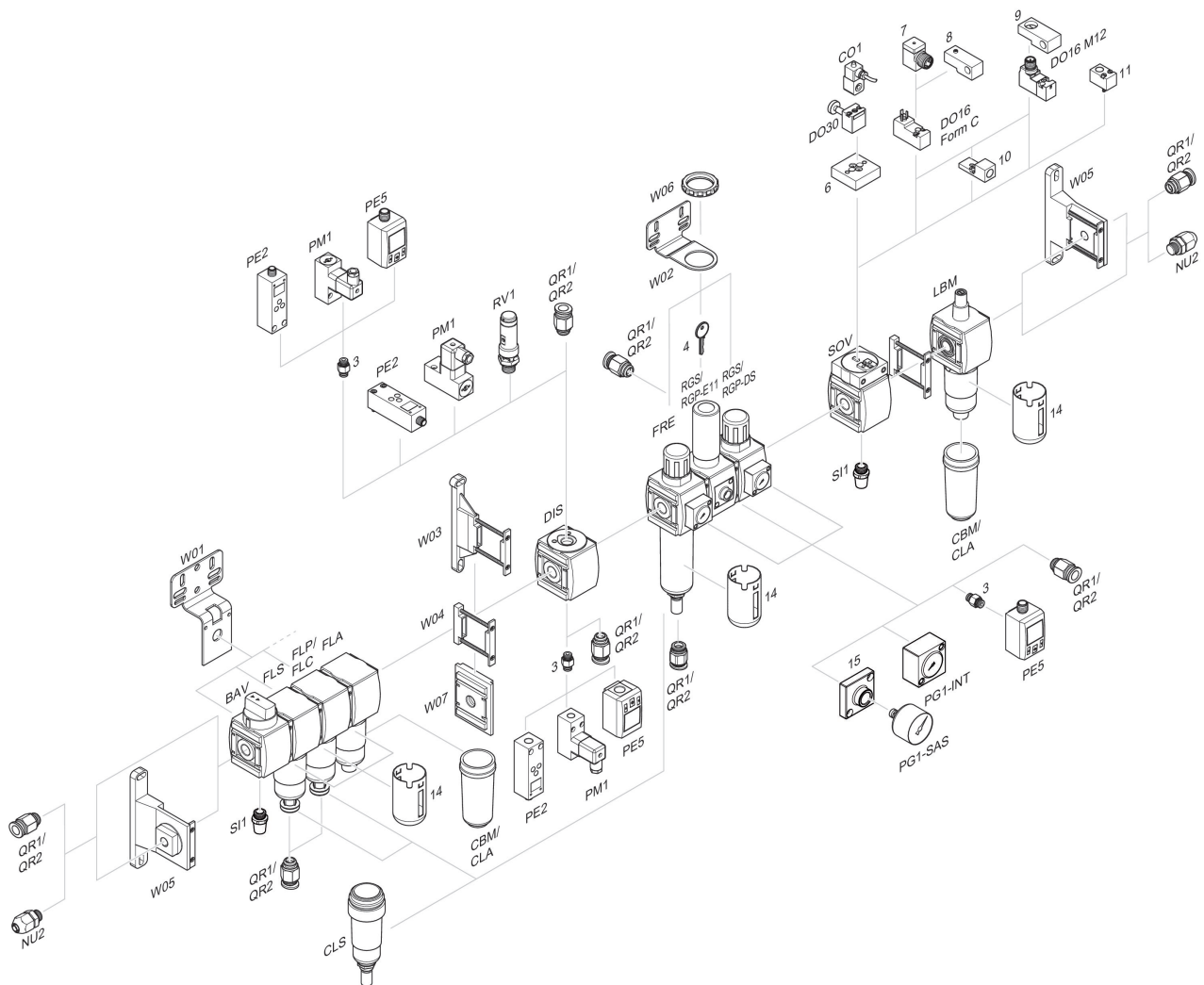

3 = Double nipple 4 = Key for E11 locking 6 = Transition plate DO30 7 = Adapter, Series CON-VP 8 = Mounting aid DO16, form C 9 = Mounting aid DO16, M12 10 = Adapter for external pilot air 11 = Adapter pneumatic operation 14 = Protective guard 15 = Transition plate for assembling a pressure gauge with connection thread G 1/8