

R412006151

Series AS2

The AVENTICS Series AS2 is a modular, versatile maintenance unit for universal application. This Series offers compact dimensions, is highly efficient, lightweight and easy-to-use. The AVENTICS Series AS guarantees reliability, safety, and efficiency with a simplified assembly and maintenance efforts.

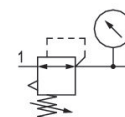

Technical data

Industry	Industrial
Function	Precision pressure regulator
Parts	Precision pressure regulator with pressure gauge
Pressure gauge	Any
Mounting orientation	Diaphragm-type pressure regulator
Regulator type	G 3/8
Port	2700 l/min
Nominal flow Qn	0.1 bar
Min. regulation range	2 bar
Max. regulation range	0.1 bar
Min. working pressure	16 bar
Max. working pressure	-10 °C
Min. ambient temperature	50 °C
Max. ambient temperature	Mechanical
Activation	with relieving air exhaust
Regulator function	Can be assembled into blocks
Regulator type	single
Pressure supply	for padlocks
Lock type	

R412006151

Max. internal air consumption q_v	2.6 l/min
Medium	Compressed air Neutral gases
Weight	0.32 kg

Material

Housing material	Polyamide
Material front plate	Acrylonitrile butadiene styrene
Seal material	Acrylonitrile butadiene rubber
Material threaded bushing	Die cast zinc
Part No.	R412006151

Technical information

The pressure dew point must be at least 15 °C less than ambient and medium temperature and may not exceed 3 °C.

The rear pressure gauge connection on the pressure regulator is closed with a blanking plug, the front connection is open. Depending on the customer application, a second blanking plug may be necessary. Please order separately (see accessories).

Nominal flow Q_n with secondary pressure $p_2 = 6$ bar at $\Delta p = 1$ bar

A change in the flow direction (from air supply on the left to air supply on the right) occurs by rotating installation by 180° about the vertical axis. Please see the operating instructions for further details.

Recommended pre-filter: 5 µm

Pressure gauge enclosed separately

Dimensions in mm

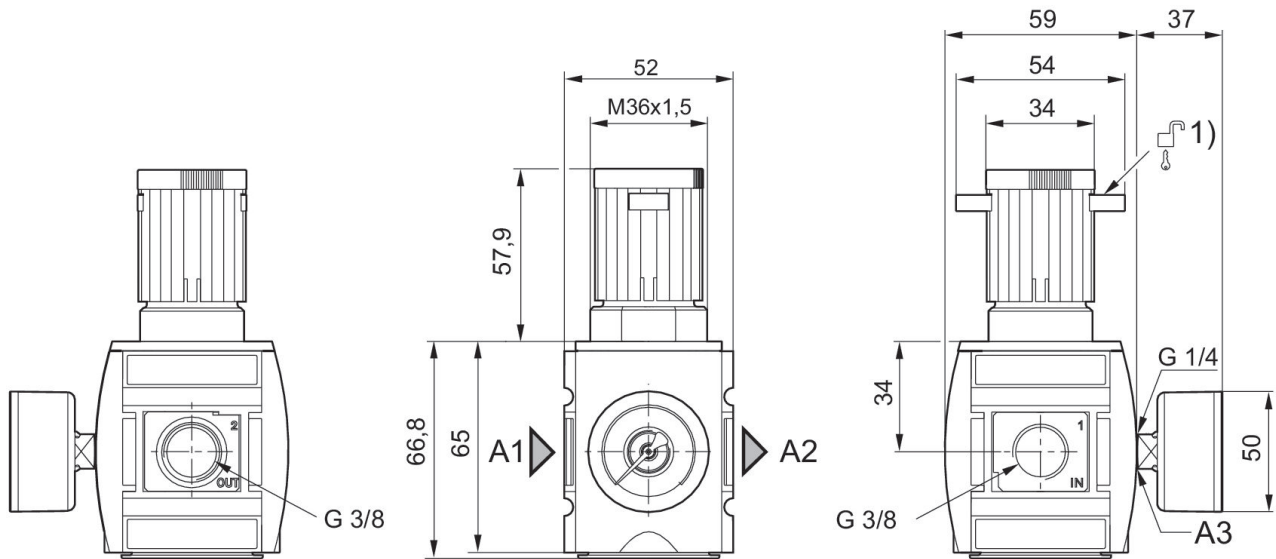

- A1 = input
- A2 = output
- A3 = pressure gauge connection
- 1) Mounting option for padlocks, max. shackle \varnothing 8

Pressure characteristics curve

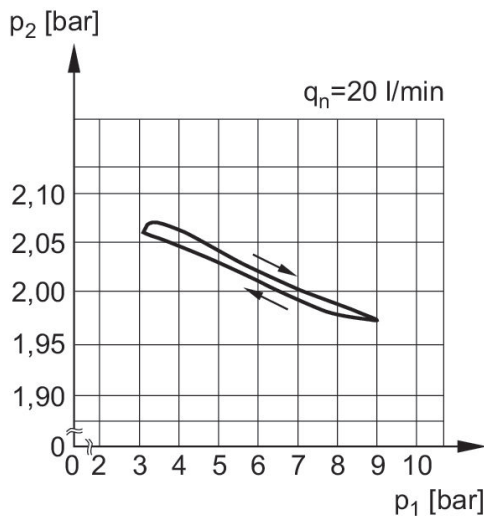

- p1 = Working pressure
- p2 = Secondary pressure
- q = flow rate

Flow rate characteristic (p2: 0,5 - 8 bar)

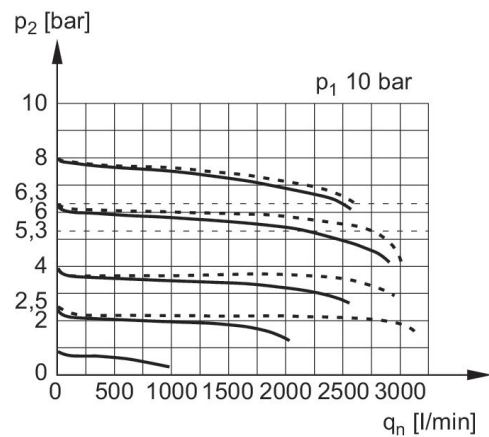

- p1 = Working pressure
- p2 = Secondary pressure
- qn = Nominal flow

Accessories overview

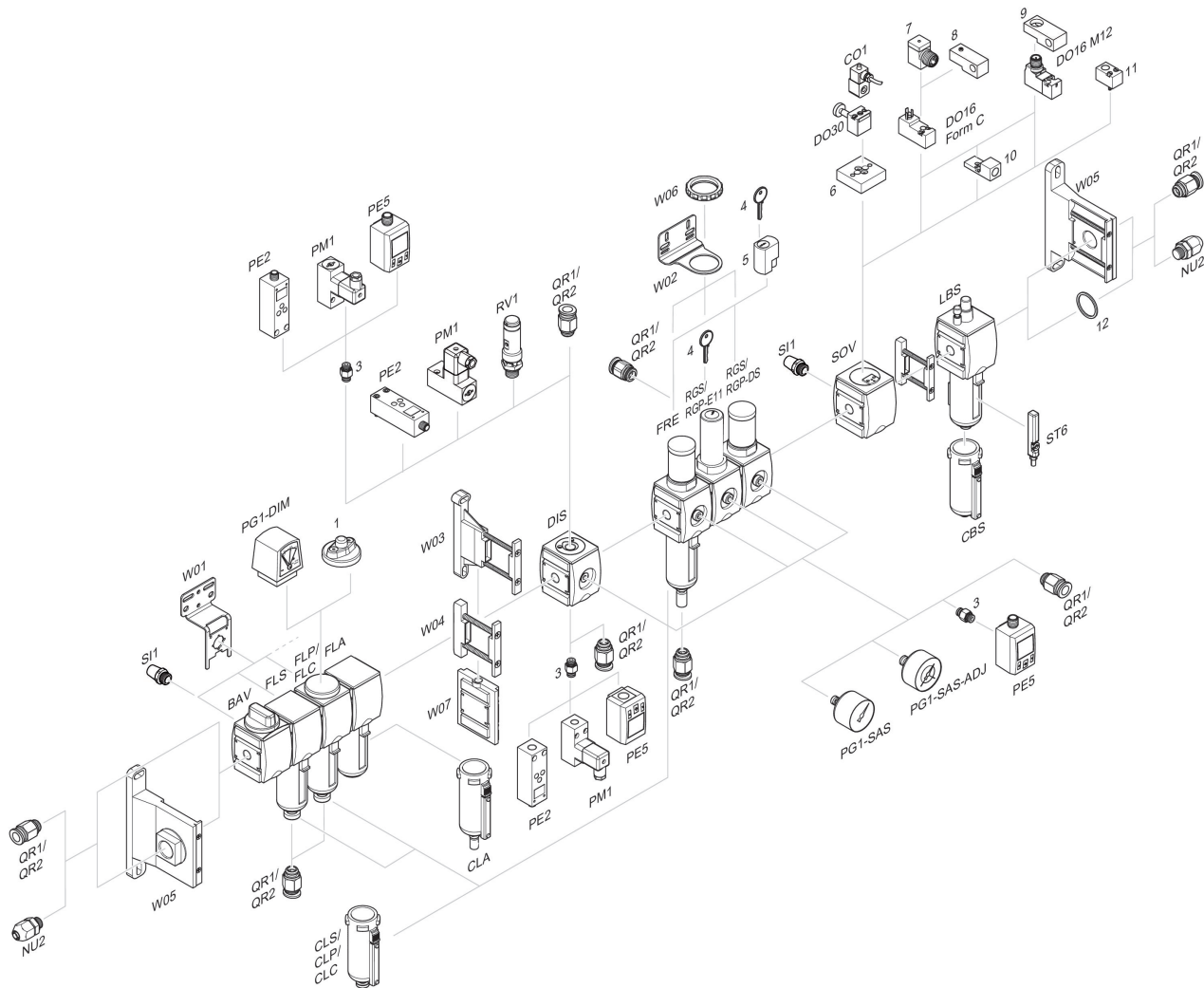

1 = contamination display 3 = Double nipple 4 = Key for E11 locking 5 = mortise lock 6 = Transition plate DO30 7 = Adapter, Series CON-VP 8 = Mounting aid DO16, form C 9 = Mounting aid DO16, M12 10 = Adapter for external pilot air 11 = Adapter pneumatic operation 12 = Sealing ring