

AVENTICS Series AS3 Air Preparation Units

The AVENTICS Series AS3 is a modular, versatile maintenance unit for universal application. This Series offers compact dimensions, is highly efficient, lightweight and easy-to-use. The AVENTICS Series AS guarantees reliability, safety, and efficiency with a simplified assembly and maintenance efforts.



Technical data

Industry

Industrial

Parts

Air preparation units

Components

Shut-off valve

Filter pressure regulator

Reservoir

reservoir, polycarbonate, with PA protective guard

Port

G 1/2

Nominal flow Qn

5100 l/min

Filter porosity

5 µm

Condensate drain

semi-automatic, open without pressure

Pressure gauge

with pressure gauge

Min. working pressure

1.5 bar

Max. working pressure

16 bar

Min. ambient temperature

-10 °C

Max. ambient temperature

50 °C

Min. regulation range

0.5 bar

Max. regulation range

8 bar

Lock type

for padlocks

Type

2-part

Type

Can be assembled into blocks

Pressure supply	single
Mounting orientation	vertical
Regulator type	Diaphragm-type pressure regulator
Regulator function	with relieving air exhaust
Filter element	exchangeable
Filter reservoir volume	49 cm ³
Max. achievable compressed air class acc. to ISO 8573-1:2010	6 : 7 : -
Medium	Compressed air Neutral gases
Weight	2.11 kg

Material

Housing material	Polyamide
Seal material	Acrylonitrile butadiene rubber
Material front plate	Acrylonitrile butadiene styrene
Material threaded bushing	Die cast zinc
Material reservoir	Polycarbonate
Material protective guard	Polyamide
Material filter insert	Polyethylene
Part No.	R412027672

Technical information

The pressure dew point must be at least 15 °C less than ambient and medium temperature and may not exceed 3 °C.

Note: Polycarbonate reservoirs are susceptible to solvents, supplementary information can be found at "Customer information".

A change in the flow direction (from air supply on the left to air supply on the right) occurs by rotating installation by 180° about the vertical axis. Please see the operating instructions for further details.

Also suitable for separation of fluid oil or water due to the design.

Nominal flow Q_n with secondary pressure $p_2 = 6$ bar at $\Delta p = 1$ bar

Air preparation unit, 2-part, Series AS3-ACC

AS3

R412027672

2024-03-20

Dimensions in mm

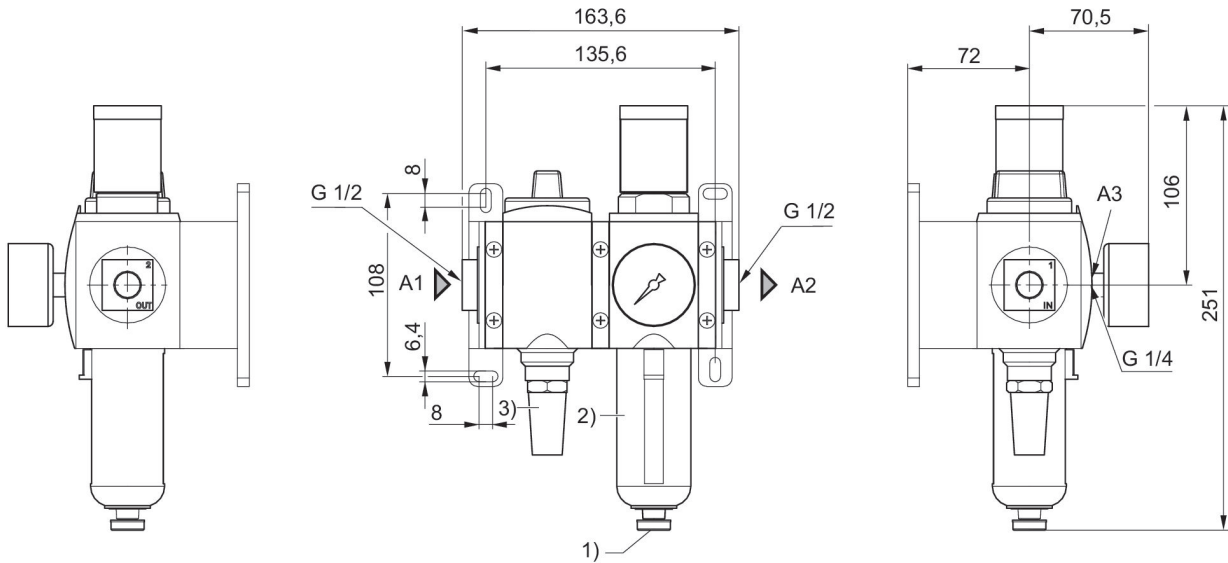

- A1 = input
- A2 = output
- A3 = pressure gauge connection
- 1) Semi-automatic condensate drain
- 2) Plastic reservoir and protective guard with window
- 3) Silencer

Block diagram

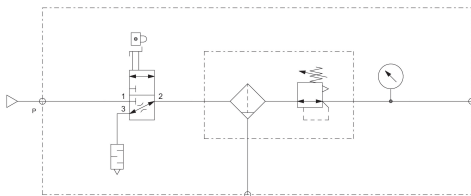

Accessories overview

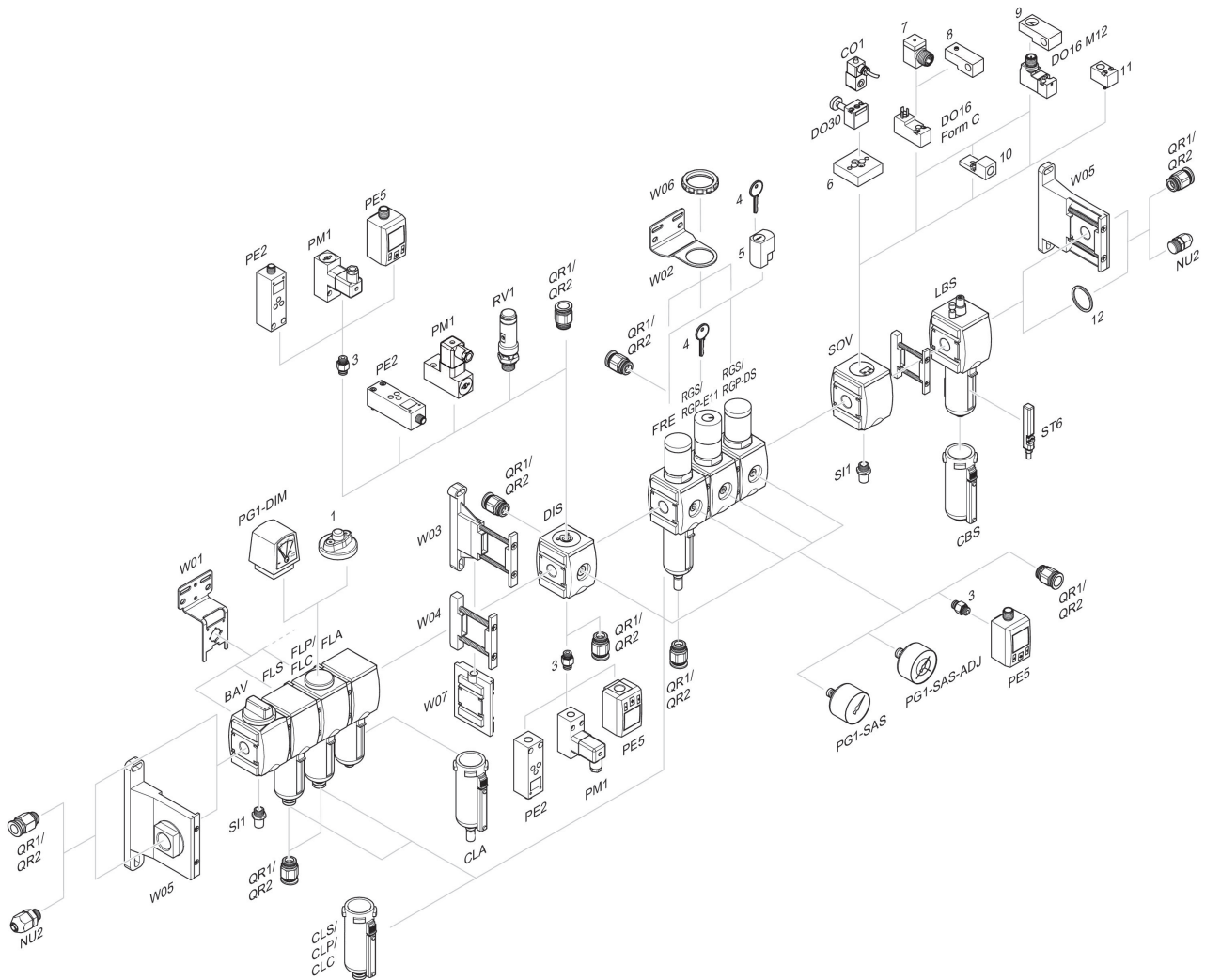

1 = contamination display 3 = Double nipple 4 = Key for E11 locking 5 = mortise lock 6 = Transition plate DO30 7 = Adapter, Series CON-VP 8 = Mounting aid DO16, form C 9 = Mounting aid DO16, M12 10 = Adapter for external pilot air 11 = Adapter pneumatic operation 12 = Sealing ring