

Series AS3

The AVENTICS Series AS3 is a modular, versatile maintenance unit for universal application. This Series offers compact dimensions, is highly efficient, lightweight and easy-to-use. The AVENTICS Series AS guarantees reliability, safety, and efficiency with a simplified assembly and maintenance efforts.



Technical data

Industry	Industrial
Parts	Diaphragm-type dryer
Type	Diaphragm-type dryer
Mounting orientation	vertical
Port	G 1/2
Nominal flow Qn	660 l/min
Recommended pre-filtering μm	5 μm 0.01 μm
Filter element	not exchangeable
Min. working pressure	4 bar
Max. working pressure	12.5 bar
Min. ambient temperature	2 °C
Max. ambient temperature	50 °C
Medium	Compressed air Neutral gases
Weight	3.56 kg

Materials:

Housing	Polyamide
Front plate	Acrylonitrile butadiene styrene

Diaphragm-type dryer, Series AS3-ADD

R412007080

Series AS3

2024-03-25

Seal	Acrylonitrile butadiene rubber
Threaded bushing	Die cast zinc
Reservoir	Aluminum
Part No.	R412007080

Technical information

The pressure dew point must be at least 15 °C less than ambient and medium temperature and may not exceed 3 °C.

Notice: air may not contain condensate

Purge air approx. 12 % of nominal flow Qn at 7 bar

A change in the flow direction (from air supply on the left to air supply on the right) occurs by rotating installation by 180° about the vertical axis. Please see the operating instructions for further details.

Pressure dew point reduction: see diagram

Diaphragm-type dryer, Series AS3-ADD

R412007080

Series AS3

2024-03-25

Dimensions in mm

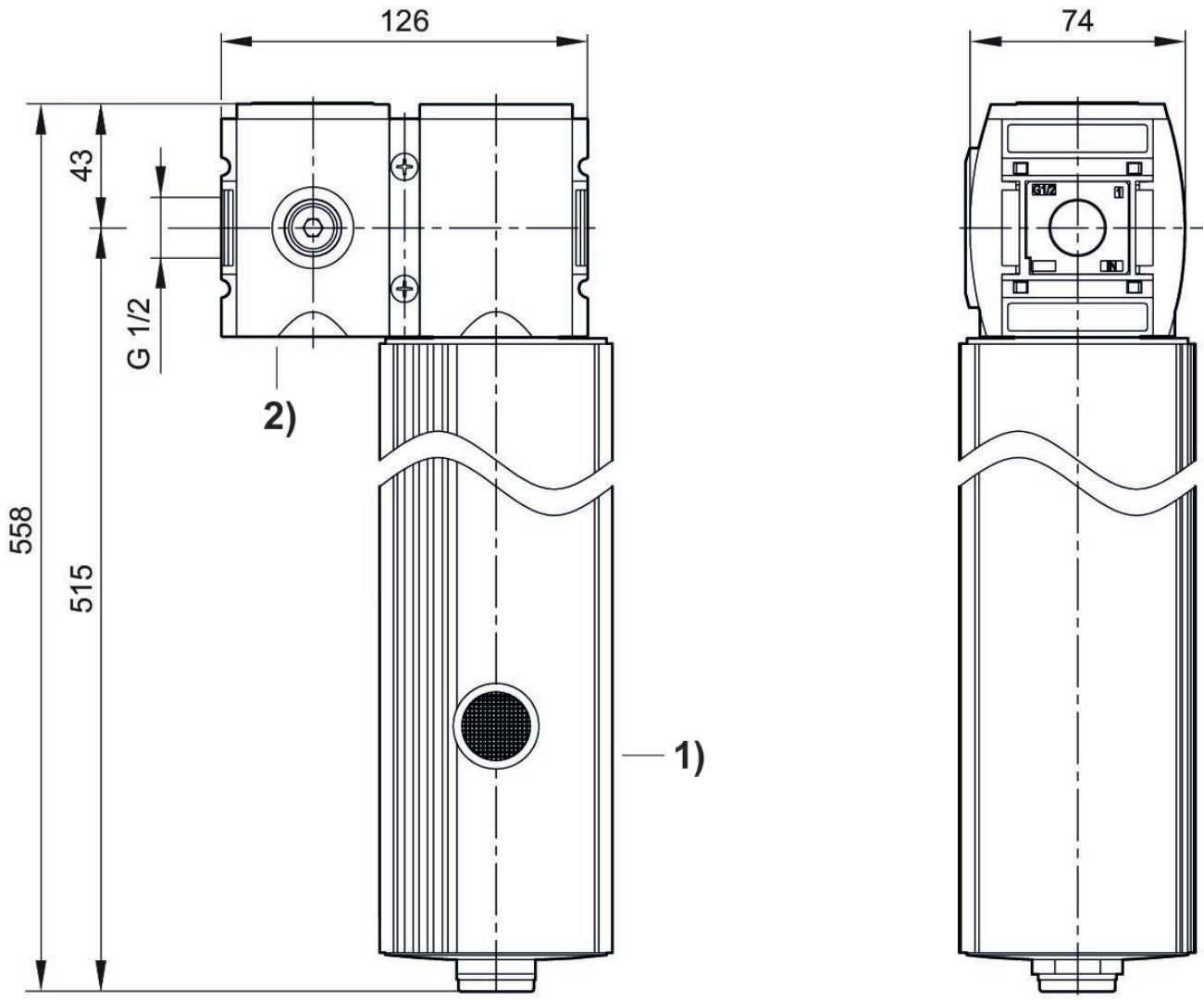

- 1) Diaphragm-type dryer
- 2) Incl. second distributor

Performance charts

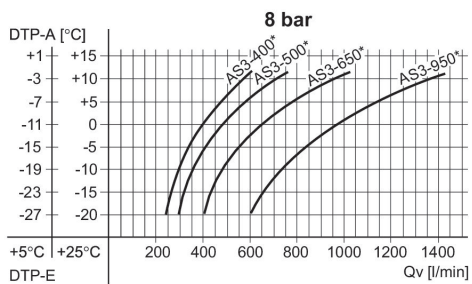

DTP-E: pressure dew point input, DTP-A: pressure dew point output, Qv: input flow rate (output flow rate + purge air).
* Nominal flow Qn

Performance charts

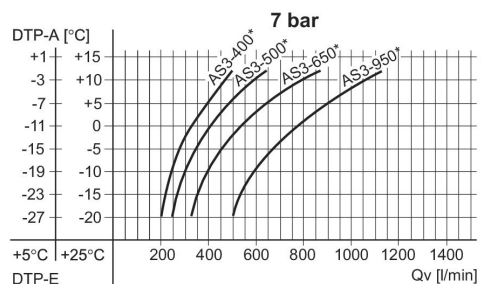

DTP-E: pressure dew point input, DTP-A: pressure dew point output, Qv: input flow rate (output flow rate + purge air).
* Nominal flow Qn

Performance charts

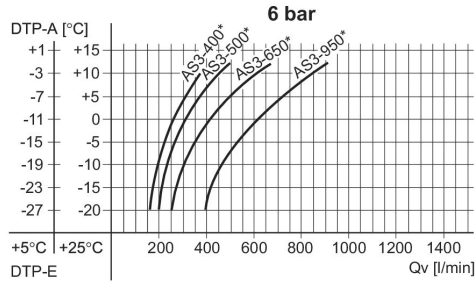

DTP-E: pressure dew point input, DTP-A: pressure dew point output, Qv: input flow rate (output flow rate + purge air).
* Nominal flow Qn

Performance charts

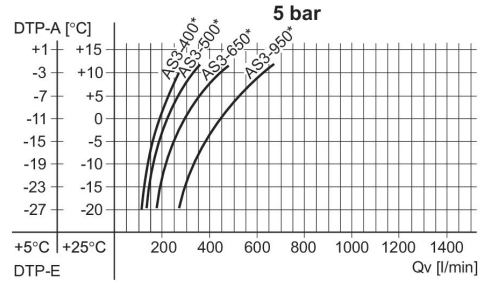

DTP-E: pressure dew point input, DTP-A: pressure dew point output, Qv: input flow rate (output flow rate + purge air).
* Nominal flow Qn

Example

Wanted:

Suitable membrane dryer

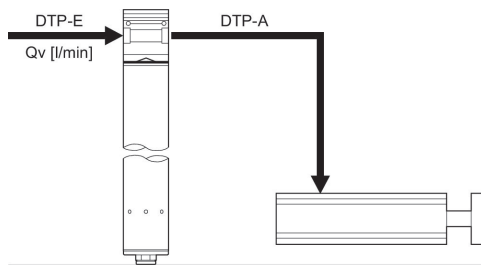

Example

Give values:

Qv = 350 l/min, DTP-E = +5 (+25) °C,

searched values: DTP-A = -15 (-3) °C a suitable membrane dryer

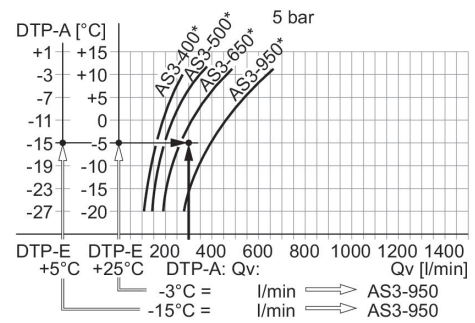

Result: membrane dryer series AS3-950 (with a Qn of 950 l/min), part no.

R412007081

* Nominal flow Qn

Diaphragm-type dryer, Series AS3-ADD

R412007080

Series AS3

2024-03-25

Accessories overview



1 = contamination display 3 = Double nipple 4 = Key for E11 locking 5 = mortise lock 6 = Transition plate DO30 7 = Adapter, Series CON-VP 8 = Mounting aid DO16, form C 9 = Mounting aid DO16, M12 10 = Adapter for external pilot air 11 = Adapter pneumatic operation 12 = Sealing ring