

Precision pressure regulator, Series AS3- RGP-...-DS

R412007160

Series AS3

2024-05-13

Series AS3

The AVENTICS Series AS3 is a modular, versatile maintenance unit for universal application. This Series offers compact dimensions, is highly efficient, lightweight and easy-to-use. The AVENTICS Series AS guarantees reliability, safety, and efficiency with a simplified assembly and maintenance efforts.

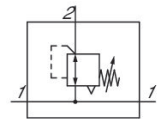

Technical data

Industry	Industrial
Function	Precision pressure regulator
Parts	Precision pressure regulator with continuous pressure supply
Pressure gauge	without pressure gauge
Mounting orientation	Any
Regulator type	Diaphragm-type pressure regulator
Port	G 3/8
Nominal flow Qn	1600 l/min
Min. regulation range	0.1 bar
Max. regulation range	1 bar
Min. working pressure	0.1 bar
Max. working pressure	16 bar
Min. ambient temperature	-10 °C
Max. ambient temperature	50 °C
Activation	Mechanical
Regulator function	with relieving air exhaust
Regulator type	Can be assembled into blocks
Pressure supply	double
Lock type	for padlocks

Precision pressure regulator, Series AS3- RGP-...-DS

Series AS3

2024-05-13

R412007160

~~with continuous pressure supply~~

~~with continuous pressure supply~~

Max. internal air consumption q_v

2.6 l/min

Max. pressure gauge \varnothing in blocked state

50 mm

Medium

Compressed air

Neutral gases

Min. medium temperature

-10 °C

Max. medium temperature

50 °C

Weight

0.528 kg

Material

Housing material

Polyamide

Material front plate

Acrylonitrile butadiene styrene

Seal material

Acrylonitrile butadiene rubber

Material threaded bushing

Die cast zinc

Part No.

R412007160

Technical information

The pressure dew point must be at least 15 °C less than ambient and medium temperature and may not exceed 3 °C.

Nominal flow Q_n with secondary pressure $p_2 = 6$ bar at $\Delta p = 1$ bar

The rear pressure gauge connection on the pressure regulator is closed with a blanking plug, the front connection is open. Depending on the customer application, a second blanking plug may be necessary. Please order separately (see accessories).

Recommended pre-filter: 5 μ m

Order pressure gauge separately

Precision pressure regulator, Series AS3- RGP-...-DS

Series AS3

2024-05-13

R412007160

Dimensions in mm

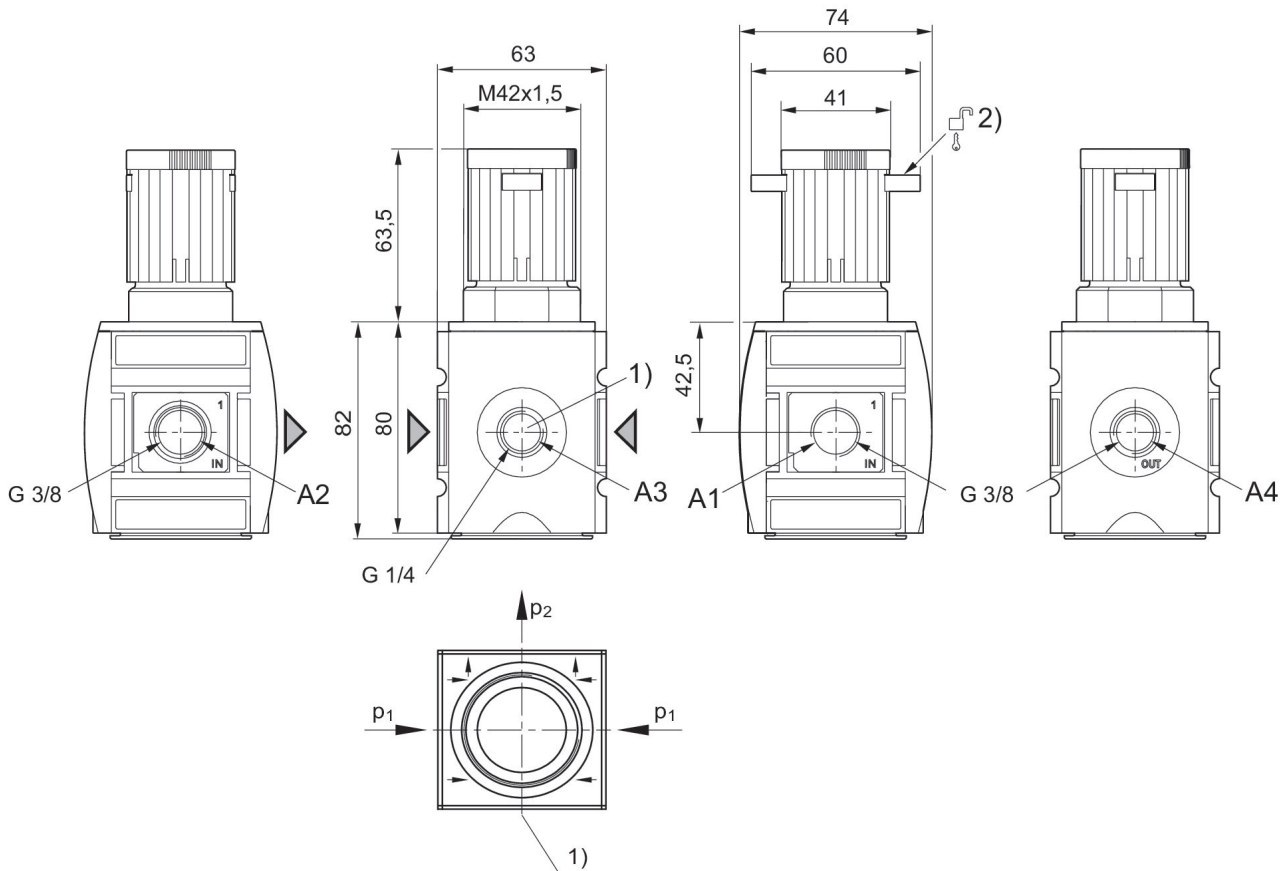

- A1 = input
- A2 = output
- A3 = pressure gauge connection
- A4 = output
- 1) Pressure gauge connection
- 2) Mounting option for padlocks, max. shackle \varnothing 8

Precision pressure regulator, Series AS3- RGP-...-DS

Series AS3

2024-05-13

R412007160

Flow rate characteristic (p2: 0,5 - 8 bar) Pressure characteristics curve

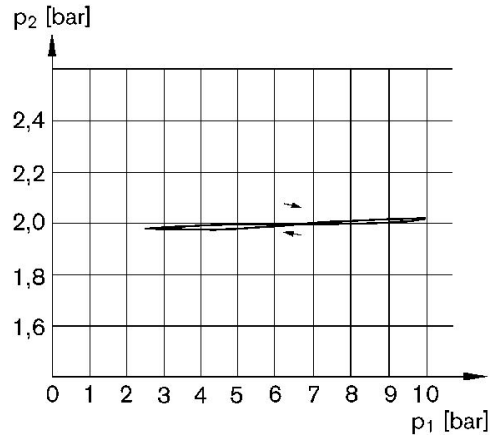
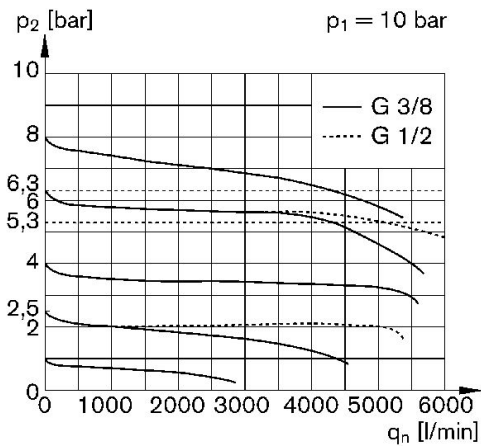

p1 = Working pressure
p2 = Secondary pressure
qn = Nominal flow

p1 = Working pressure
p2 = Secondary pressure

Application example

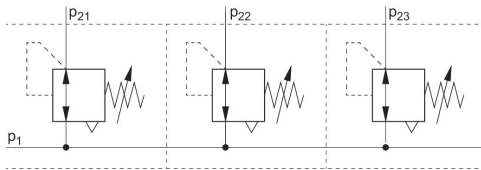

p1 = Working pressure

Precision pressure regulator, Series AS3- RGP-...-DS

Series AS3

2024-05-13

R412007160
Accessories overview

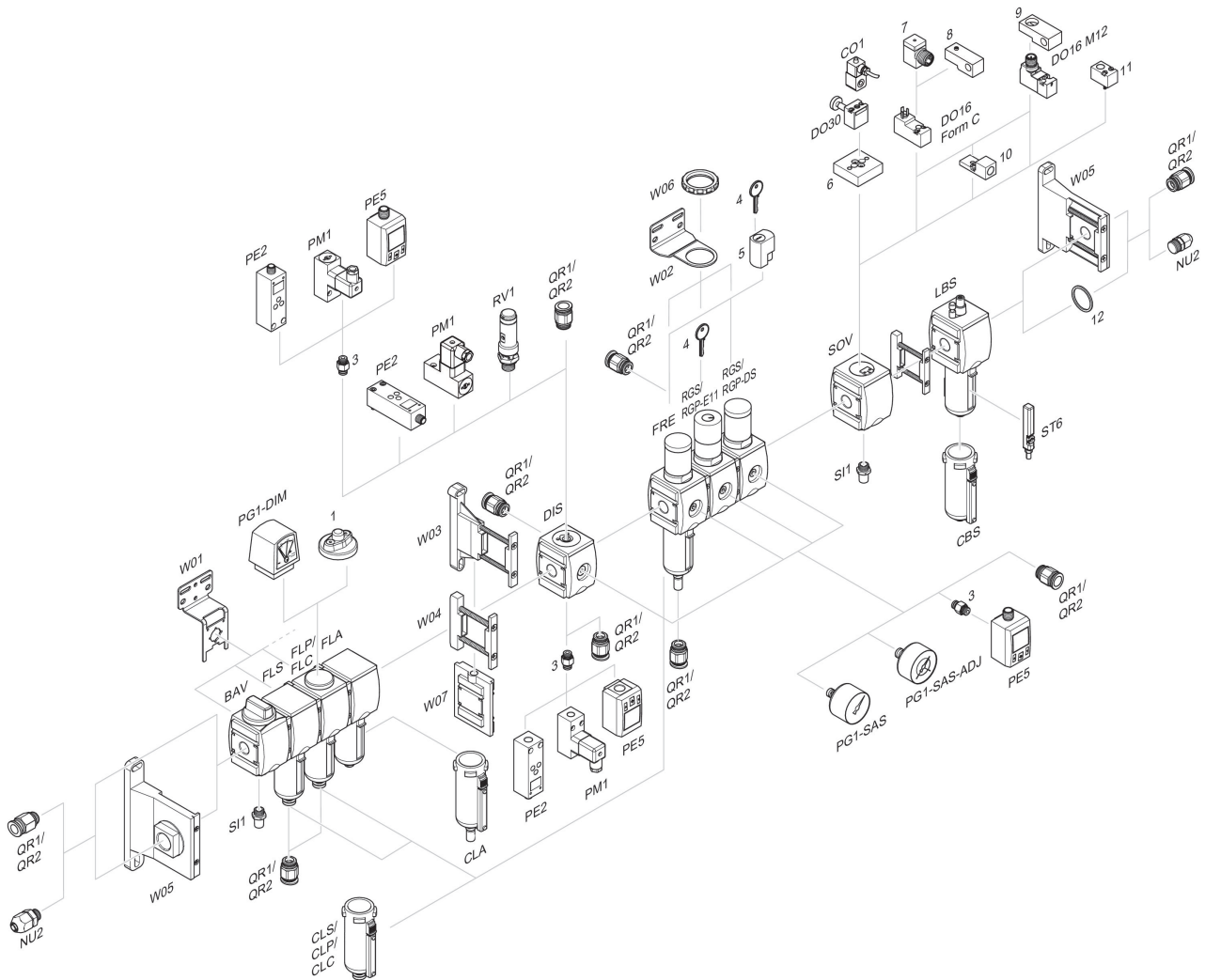

1 = contamination display 3 = Double nipple 4 = Key for E11 locking 5 = mortise lock 6 = Transition plate DO30 7 = Adapter, Series CON-VP 8 = Mounting aid DO16, form C 9 = Mounting aid DO16, M12 10 = Adapter for external pilot air 11 = Adapter pneumatic operation 12 = Sealing ring