

## Series AS3

The AVENTICS Series AS3 is a modular, versatile maintenance unit for universal application. This Series offers compact dimensions, is highly efficient, lightweight and easy-to-use. The AVENTICS Series AS guarantees reliability, safety, and efficiency with a simplified assembly and maintenance efforts.

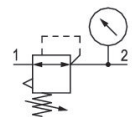

## Technical data

Industry	Industrial
Function	Standard pressure regulator
Parts	Pressure regulator
Pressure gauge	with pressure gauge
Mounting orientation	Any
Regulator type	Diaphragm-type pressure regulator
Port	G 3/8
Nominal flow Qn	5000 l/min
Min. regulation range	0.2 bar
Max. regulation range	4 bar
Min. working pressure	0.2 bar
Max. working pressure	16 bar
Min. ambient temperature	-10 °C
Max. ambient temperature	50 °C
Activation	Mechanical
Regulator function	with relieving air exhaust
Regulator type	Can be assembled into blocks
Pressure supply	single
Lock type	for padlocks

# Pressure regulator, Series AS3-RGS

Series AS3

R412007105

2024-04-19

---

Medium	Compressed air Neutral gases
Min. medium temperature	-10 °C
Max. medium temperature	50 °C
Weight	0.6 kg

## Material

Housing material	Polyamide
Material front plate	Acrylonitrile butadiene styrene
Seal material	Acrylonitrile butadiene rubber
Part No.	R412007105

## Technical information

The pressure dew point must be at least 15 °C less than ambient and medium temperature and may not exceed 3 °C.

Nominal flow  $Q_n$  with secondary pressure  $p_2 = 6$  bar at  $\Delta p = 1$  bar

The rear pressure gauge connection on the pressure regulator is closed with a blanking plug, the front connection is open. Depending on the customer application, a second blanking plug may be necessary. Please order separately (see accessories).

A change in the flow direction (from air supply on the left to air supply on the right) occurs by rotating installation by 180° about the vertical axis. Please see the operating instructions for further details.

Relieving exhaust ( $\leq 0.3$  bar over set pressure)

With rear exhaust ( $>3$  bar)

Pressure gauge enclosed separately

The delivered product may vary from that in the illustration.

## Dimensions in mm

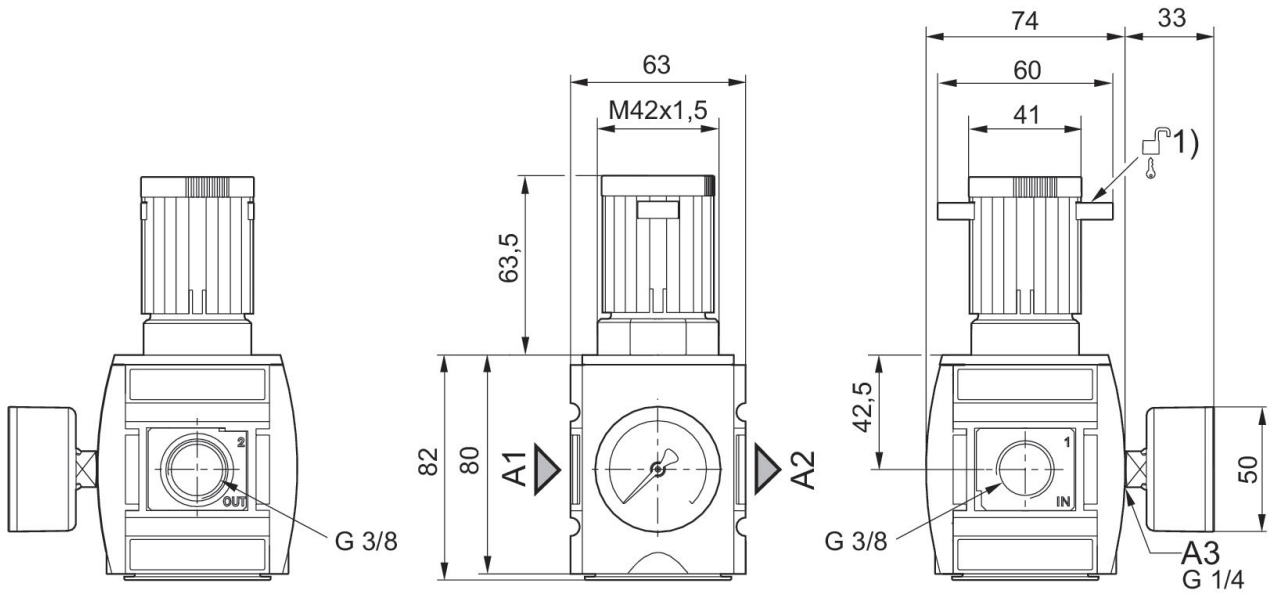

A1 = input  
 A2 = output  
 A3 = pressure gauge connection  
 1) Mounting option for padlocks, max. shackle  $\varnothing$  8

## Flow rate characteristic (p2: 0,5 - 8 bar)

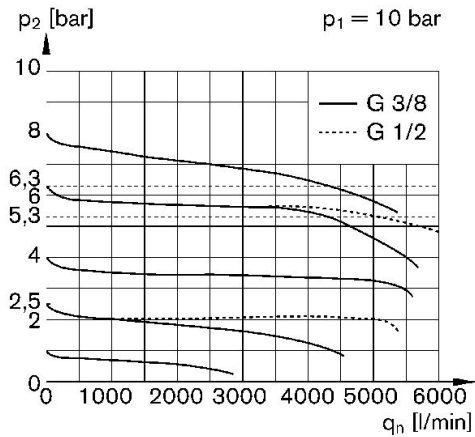

$p_1$  = Working pressure  
 $p_2$  = Secondary pressure  
 $q_n$  = Nominal flow

## Pressure characteristics curve Standard version

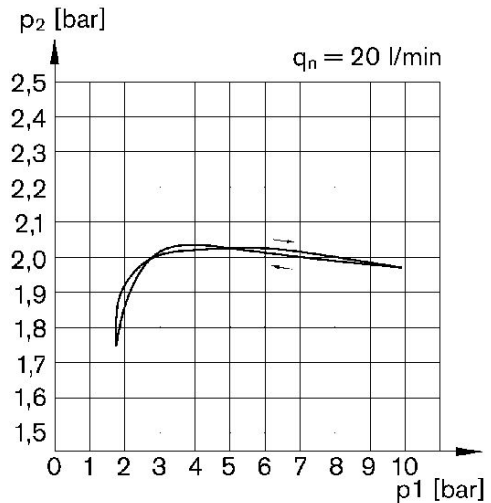

$p_1$  = Working pressure  
 $p_2$  = Secondary pressure  
 $q_n$  = Nominal flow

## Accessories overview

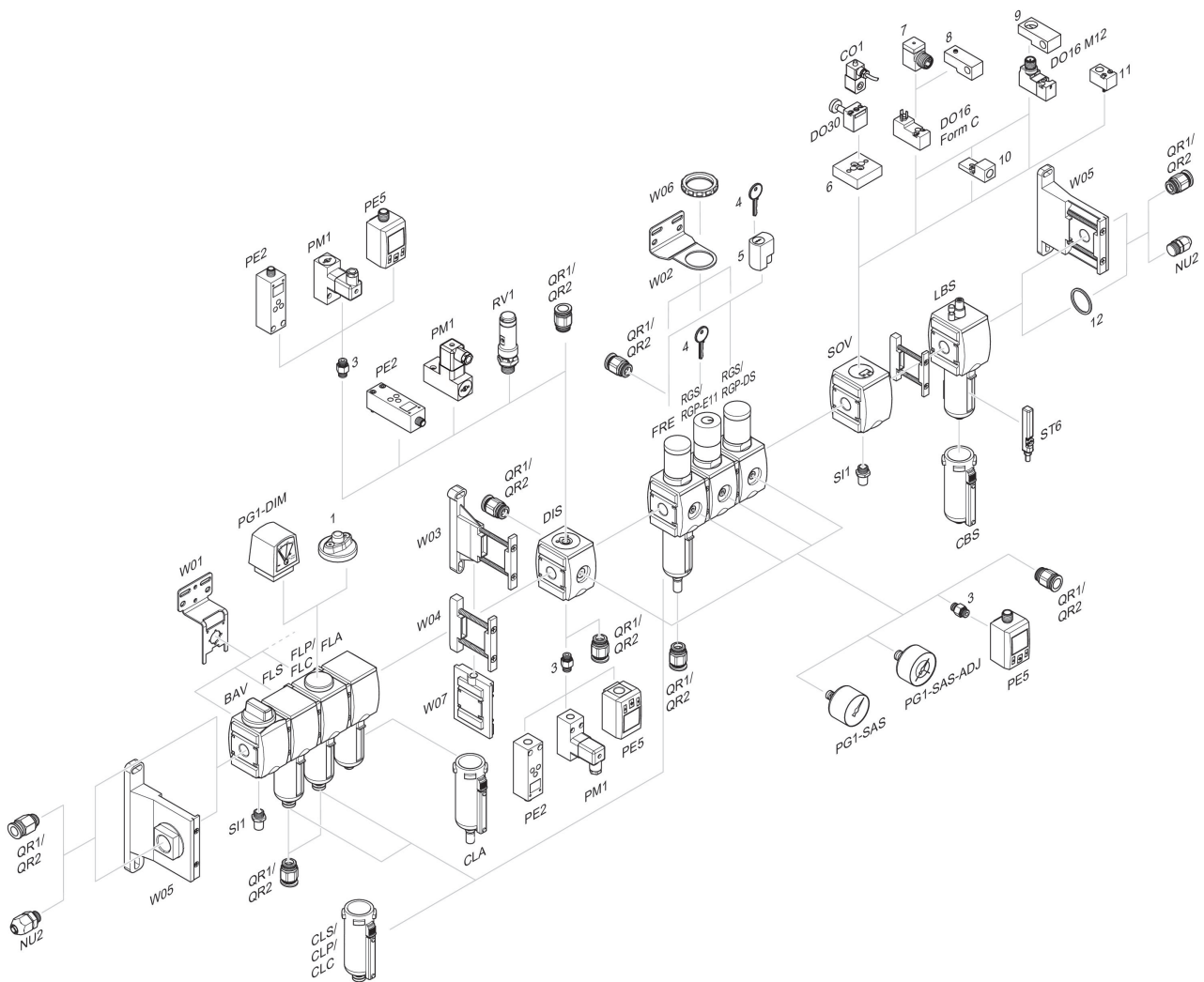

1 = contamination display 3 = Double nipple 4 = Key for E11 locking 5 = mortise lock 6 = Transition plate DO30 7 = Adapter, Series CON-VP 8 = Mounting aid DO16, form C 9 = Mounting aid DO16, M12 10 = Adapter for external pilot air 11 = Adapter pneumatic operation 12 = Sealing ring