

## Series AV03

The AVENTICS Series AV03/AV05 provide a reliable basis for both compact handling systems and complex automation solutions. Within machine safety the Series AV03/AV05 offers intelligent solutions that significantly reduce your effort in creating a safe design. With the integration of the fieldbus and I/O-modules of the Series AES, also all requirements for distributed control are available. The Series AV03/AV05 is easy to configure, easy to use and easy to extend as well as IIoT futureproof thanks to the integration of OPC UA and the Digital Twin

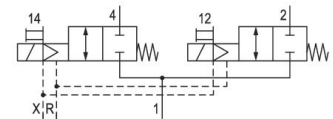

## Technical data

Industry	Industrial
Activation	Electrically
Valve type	Spool valve, positive overlapping
Switching principle	2x 2/2 NC/NC, with spring return
Valve function	NC/NC
Actuating control	Double Solenoid
Sealing principle	Soft seal
Connection type	Plate connection
Manual override	with detent
Pilot control exhaust	with directional pilot air exhaust
Nominal flow Qn	280 l/min
Flow conductance b	0.4
Flow conductance C	1.17 l/(s*bar)
Min. working pressure	-0.9 bar
Max. working pressure	10 bar
Min. control pressure	3 bar

# 2x2/2-directional valve, Series AV03

2024-03-19

R422102437

---

Max. control pressure	8 bar
Protection class with connection	IP65
Protective circuit	Z-diode
Reverse polarity protection	Protected against polarity reversal
Operational voltage	24 V DC
Operational voltage DC	24 V
Voltage tolerance DC	-10% / +10%
Pilot	External
LED status display	Yellow
Power consumption DC	0.55 W
Duty cycle	100 %
Typ. switch-on time	16 ms
Typ. switch-off time	20 ms
Blocking principle	Base plate principle, multiple
Min. ambient temperature	-10 °C
Max. ambient temperature	60 °C
Min. medium temperature	-10 °C
Max. medium temperature	60 °C
Medium	Compressed air
Min. oil content of compressed air	0 mg/m <sup>3</sup>
Max. oil content of compressed air	5 mg/m <sup>3</sup>
Max. particle size	40 µm
Mounting screws	Hexalobular socket (TORX) ISO 10664-8
Mounting screw tightening torque	0.52 Nm
Weight	0.052 kg

## Material

Housing material	Polyamide fiber-glass reinforced
Seal material	Acrylonitrile butadiene rubber Hydrogenated acrylonitrile butadiene rubber
Material front plate	Polyamide fiber-glass reinforced
Material end plate	Polyamide
Part No.	R422102437

## Technical information

The min. control pressure must be adhered to, since otherwise faulty switching and valve failure may result!

The pressure dew point must be at least 15 °C less than ambient and medium temperature and may not exceed 3 °C.

The oil content of compressed air must remain constant during the life cycle.

Use only the approved oils from AVENTICS. Further information can be found in the "Technical information" document (available in <https://www.emerson.com/en-us/support>).

## Dimensions

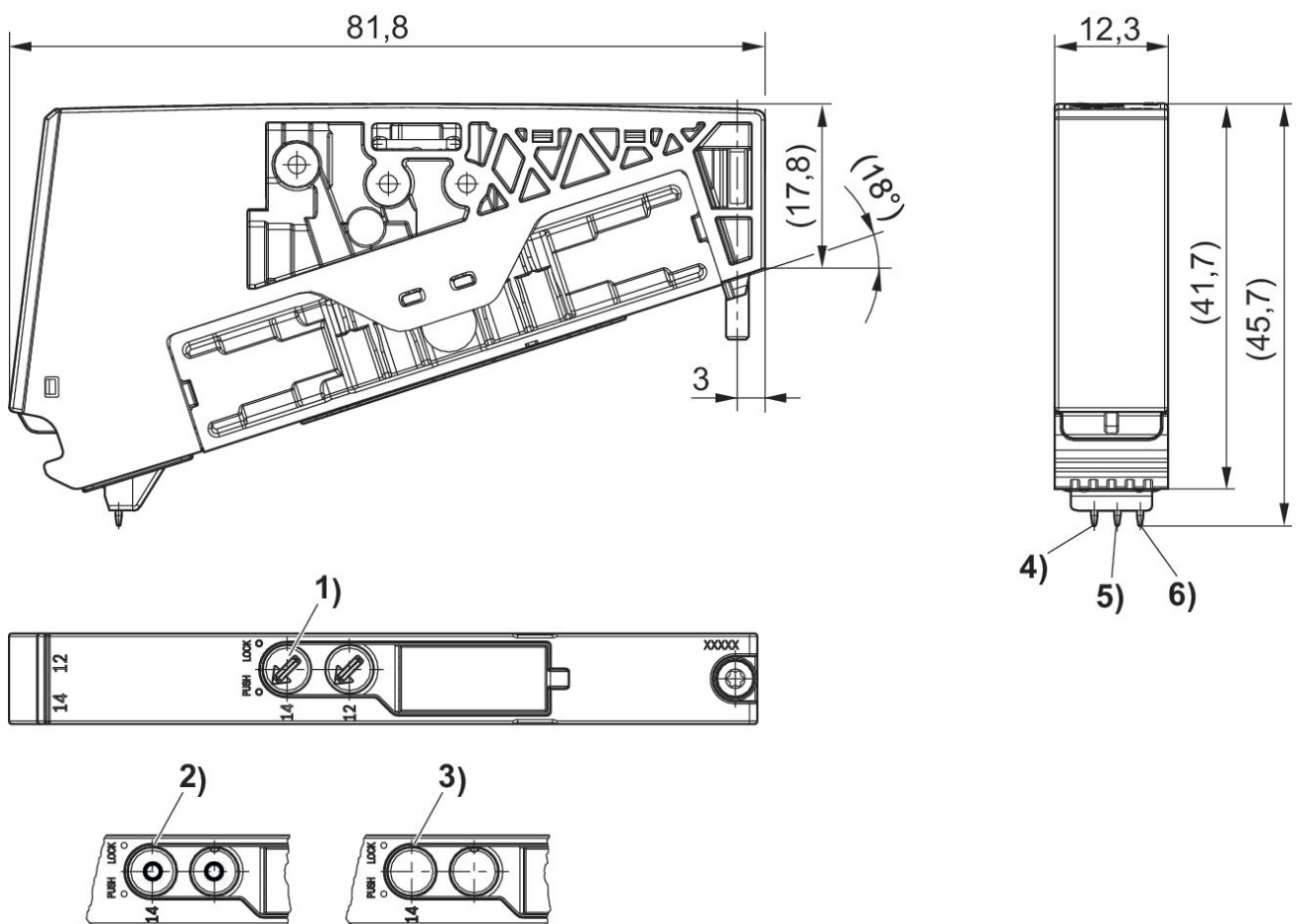

- 1) Manual override: with detent
- 2) manual override: without detent
- 3) Manual override: without detent
- 4) Coil 12
- 5) Coil 14
- 6) Ground

# 2x2/2-directional valve, Series AV03

2024-03-19

R422102437

---

Control pressure: see diagram for min., max. 8 bar

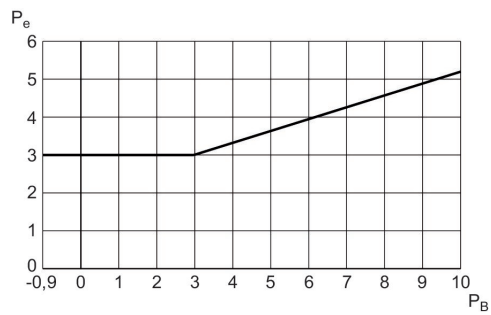

---

$P_B$  = Working pressure  
 $P_e$  = external control pressure, min.