

Series BCC

R412020586

AVENTICS
Series BCC
Bellow
actuators

2024-03-15

AVENTICS Series BCC Bellow actuators

The AVENTICS Series BCC cylinders are bellow cylinders with removable mounting parts. Users have the option of replacing the rubber bellows themselves. Mounting via internal thread or threaded bolt.



Technical data

Industry	Industrial
Bellows	single
Type	Bellow actuator with mounting ring and cover
Functional principle	Single-acting, retracted without pressure
Compressed air connection	G 1/2
Cover diameter	184 mm
Feature	8x1
Max. permissible angle of tilt	20 °
Max. effective stroke	65 mm
Min. radial installation space	245 mm
Min. installation height	50 mm
Max. installation height	115 mm
Min. force	8000 N
Max. force	18000 N
Min. working pressure	0 bar
Max. working pressure	8 bar
Min. ambient temperature	-40 °C
Max. ambient temperature	70 °C
Medium	Compressed air

Series BCC

R412020586

AVENTICS
Series BCC
Bellow
actuators

2024-03-15

Reduced service life at a temperature greater than 50 °C

Pressure for determining forces 6 bar
Weight 3.1 kg

Material

Material bellow caoutchouc/butadiene caoutchouc
Material front cover Steel, chrome-plated
Surface cover galvanized
Part No. R412020586

Technical information

Compliance with the minimum height H min. as well as the maximum height H max. must be ensured with end stops.

Use at operating height $\geq H_{max}$: only permitted upon approval by AVENTICS

Further information on vibration isolation can be found in the "Technical information" document (available in the MediaCentre).

The bellow can be exchanged.

The pressure dew point must be at least 15 °C less than ambient and medium temperature and may not exceed 3 °C.

The oil content of compressed air must remain constant during the life cycle.

Use only the approved oils from AVENTICS. Further information can be found in the "Technical information" document (available in <https://www.emerson.com/en-us/support>).

Dimensions

Series BCC

R412020586

AVENTICS

Series BCC

Bellow

actuators

2024-03-15

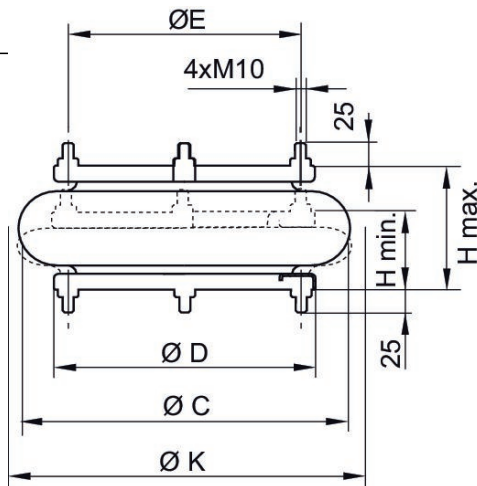

Part No.	Compressed air connection	H min.	H max.	C	D	E	K	Min. re- turn force
R412020590	G 1/2	50	175	420	310	282.5	445	30

Part No.	Compressed air connection	H min.	H max.	C	D	E	K	Min. re- turn force
R412020589	G 1/2	50	150	400	310	282.5	425	230

Part No.	Compressed air connection	H min.	H max.	C	D	E	K	Min. re- turn force
R412020588	G 1/2	50	135	330	260	232	350	200

Part No.	Compressed air connection	H min.	H max.	C	D	E	K	Min. re- turn force
R412020587	G 1/2	50	135	270	210	181	300	150

Series BCC

R412020586

AVENTICS
Series BCC
Bellow
actuators

2024-03-15

Part No.	Compressed air connection	H min.	H max.	C	D	E	K	Min. re- turn force
R412020586	G 1/2	50	115	230	184	155.5	245	290

Part No.	Compressed air connection G	H min.	H max.	C	D	E	K	Min. re- turn force
R412020585	G 1/2	50	95	175	153,5	127	190	320