

Series BCC

R412000012

AVENTICS
Series BCC
Bellow
actuators

2024-03-15

AVENTICS Series BCC Bellow actuators

The AVENTICS Series BCC cylinders are bellow cylinders with removable mounting parts. Users have the option of replacing the rubber bellows themselves. Mounting via internal thread or threaded bolt.



Technical data

Industry	Industrial
Bellows	triple
Type	Bellow actuator with mounting ring and cover
Functional principle	Single-acting, retracted without pressure
Compressed air connection	G 1/2
Cover diameter	210 mm
Feature	10x3
Max. permissible angle of tilt	30 °
Max. effective stroke	250 mm
Min. radial installation space	300 mm
Min. installation height	100 mm
Max. installation height	350 mm
Min. force	12000 N
Max. force	26000 N
Min. working pressure	0 bar
Max. working pressure	8 bar
Min. ambient temperature	-40 °C
Max. ambient temperature	70 °C
Medium	Compressed air

Series BCC

R412000012

AVENTICS
Series BCC
Bellow
actuators

2024-03-15

Reduced service life at a temperature greater than 50 °C

Pressure for determining forces 6 bar
Weight 5.2 kg

Material

Material bellow caoutchouc/butadiene caoutchouc
Material front cover Steel, chrome-plated
Surface cover galvanized
Part No. R412000012

Technical information

Compliance with the minimum height H min. as well as the maximum height H max. must be ensured with end stops.

Use at operating height $\geq H_{max}$: only permitted upon approval by AVENTICS

Further information on vibration isolation can be found in the "Technical information" document (available in the MediaCentre).

The bellow can be exchanged.

The pressure dew point must be at least 15 °C less than ambient and medium temperature and may not exceed 3 °C.

The oil content of compressed air must remain constant during the life cycle.

Use only the approved oils from AVENTICS. Further information can be found in the "Technical information" document (available in <https://www.emerson.com/en-us/support>).

Dimensions

Series BCC

R412000012

AVENTICS
Series BCC
Bellows
actuators

2024-03-15

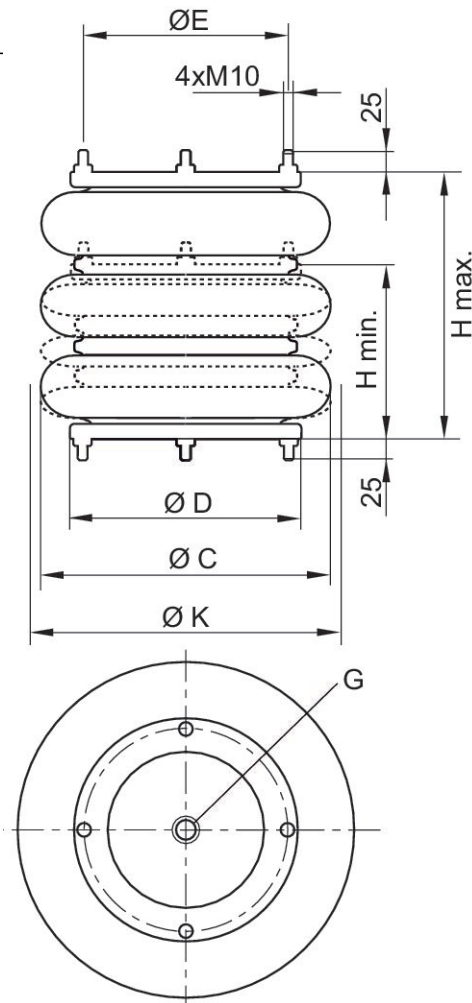

Part No.	Compressed air connection G	H min. mm	H max. mm	C mm	D mm	E mm	K mm	Min. return force N
R412020604	G 1/2	120	475	430	310	282.5	455	100

Part No.	Compressed air connection G	H min. mm	H max. mm	C mm	D mm	E mm	K mm	Min. return force N
R412020603	G 1/2	100	420	400	310	282.5	425	330

Part No.	Compressed air connection G	H min. mm	H max. mm	C mm	D mm	E mm	K mm	Min. return force N
R412020602	G 1/2	100	350	330	260	232	350	250

Series BCC

R412000012

AVENTICS
Series BCC
Bellow
actuators

2024-03-15

Part No.	Compressed air connection G	H min. mm	H max. mm	C mm	D mm	E mm	K mm	Min. return force N
R412000012	G 1/2	100	350	270	210	181	300	250

Part No.	Compressed air connection G	H min. mm	H max. mm	C mm	D mm	E mm	K mm	Min. return force N
R412020601	G 1/2	100	305	230	184	155.5	245	350

Part No.	Compressed air connection G	H min. mm	H max. mm	C mm	D mm	E mm	K mm	Min. return force N
R412020600	G 1/2	95	255	178	153,5	127	195	250