

# Bellow actuator with cover, series BCP, single, air connection between 3 mounting holes

Series BCP

2024-09-12

R412010199

- Bellow cylinder with permanently crimped connecting plates
- Permit high forces in small installation space
- Enables angular movements and axial offset
- High corrosion and temperature resistance
- Tested safety up to 24 bar

## AVENTICS Series BCP Bellow actuators

The AVENTICS Series BCP cylinders are bellow actuators with firmly flanged steel covers and bellows made of natural rubber in the standard version. The heat-resistant version is distinguished by bellows made of epichlorohydrin rubber (ECO) and the corrosion-resistant version by stainless steel covers (V2A).

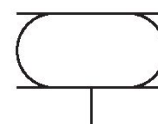

## Technical data

Industry	Industrial
Bellows	single
Type	Bellow actuator with cover
Functional principle	Single-acting, retracted without pressure
Compressed air connection	G 1/4
Cover diameter	114 mm
Max. permissible angle of tilt	15 °
Max. effective stroke	79 mm
Min. radial installation space	225 mm
Min. installation height	51 mm
Max. installation height	130 mm
Min. force	4300 N
Max. force	10900 N
Min. working pressure	0 bar
Max. working pressure	8 bar
Min. ambient temperature	-40 °C
Max. ambient temperature	70 °C
Medium	Compressed air
Reduced service life at a temperature greater than	50 °C

# Bellow actuator with cover, series BCP, single, air connection between 3 mounting holes

Series BCP

2024-09-12

R412010199

Pressure for determining forces 6 bar

---

Weight 1.4 kg

## Material

Material bellow caoutchouc/butadiene caoutchouc

Material front cover Steel, chrome-plated

Surface cover galvanized

Part No. R412010199

## Technical information

Compliance with the minimum height H min. as well as the maximum height H max. must be ensured with end stops.

Use at operating height  $\geq H_{max}$ : only permitted upon approval by AVENTICS

Further information on vibration isolation can be found in the "Technical information" document (available in the MediaCentre).

# Bellow actuator with cover, series BCP, single, air connection between 3 mounting holes

Series BCP

2024-09-12

R412010199  
Dimensions

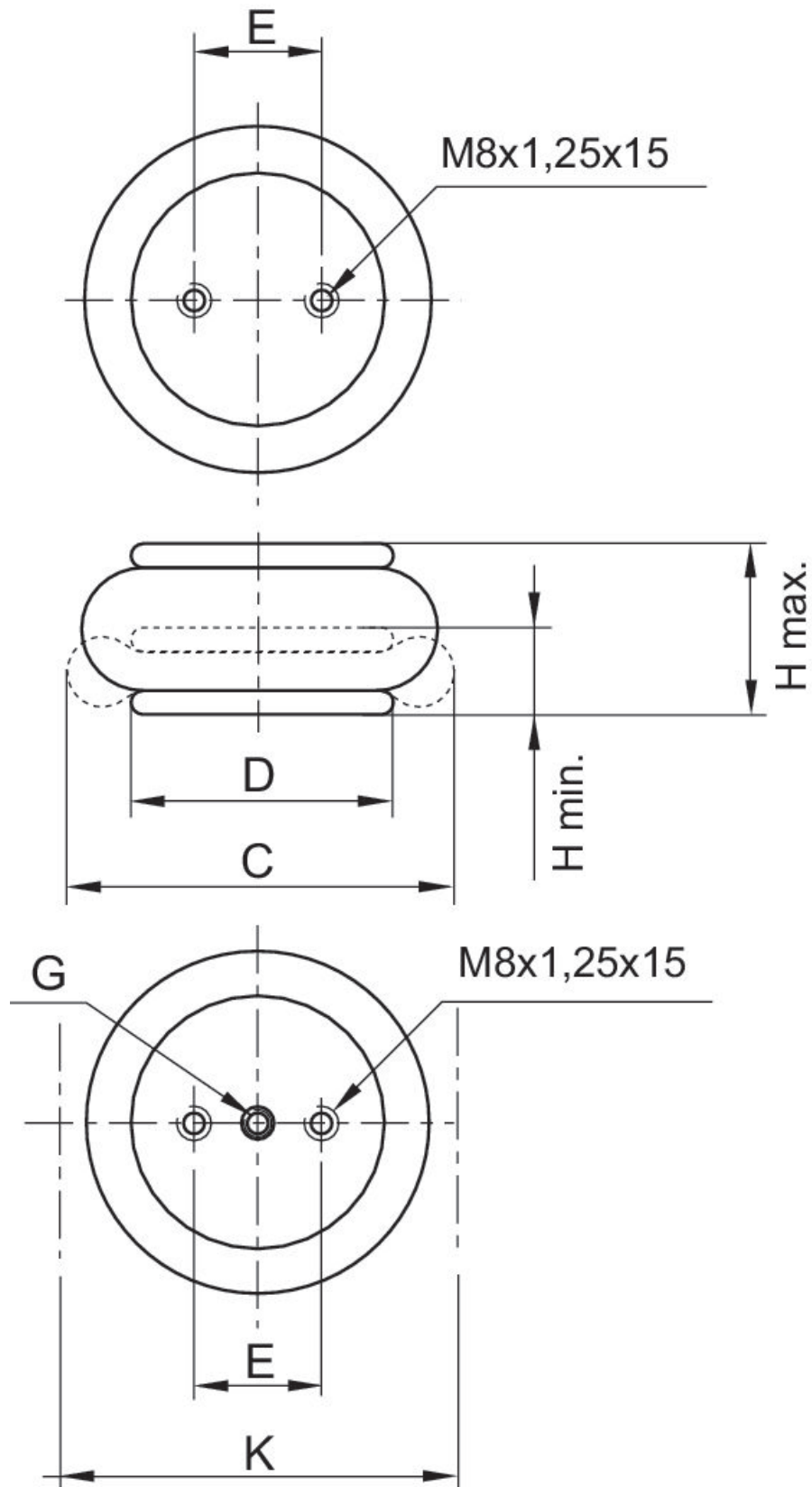

# Bellow actuator with cover, series BCP, single, air connection between 3 mounting holes

Series BCP

2024-09-12

R412010199

Part No.	Compressed air connection G	H min. mm	H max. mm	C mm	D mm	E ±0,5 [mm]	K mm	Min. return force N
R412010198	G 1/4	51	85	150	108	44.5	165	250
0822419002	G 1/4	51	105	165	108	44.5	180	200
R412010199	G 1/4	51	130	210	114	44.5	225	45
0822419003	G 3/4	50	125	215	141	70	230	200
1923061000	G 3/4	51	130	231	141	70	245	200
R412010197	G 3/4	51	158	235	141	70	250	200

## Comment

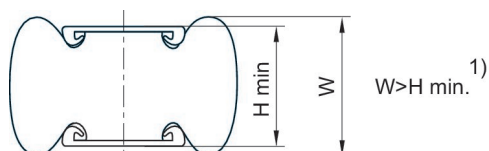

1) Once the minimum height H min. is reached, the bead height W can fall below the lower limit. If, for these products, level mounting surfaces greater than the cover diameter are selected, the return force and force output at the start of stroke increase. In the process, the rubber bellow is also compressed by the mounting surfaces. These products require more space upward, which can, in rare cases, present a hindrance. In any case, the specifications of the data sheets apply when using mounting surfaces in the size of the bellows actuator cover.

1 kN = 1000 N

## Force-displacement diagram

R412010199

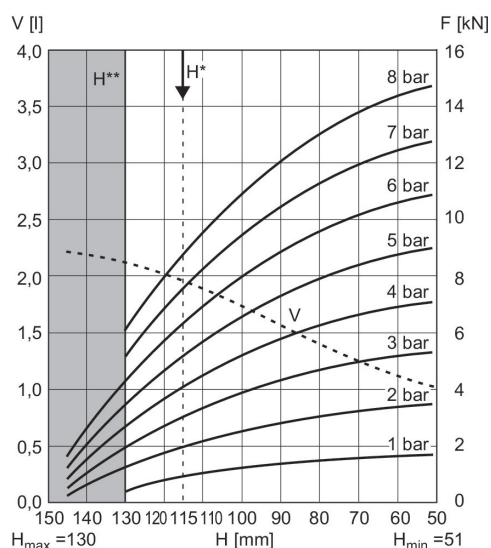

V = volume H = height H\* = recommended operating height for vibration isolation H\*\* = use permitted only upon approval by AVENTICS  
1 kN = 1000 N