

AVENTICS Series BSG Bellow suction grippers

AVENTICS Series BSG bellow suction grippers are suitable for workpieces with curved or inclined surfaces, as well as to compensate for height tolerances or to handle large-surface, non-rigid components such as large, thin sheets.



Technical data

Industry	Industrial
Min. ambient temperature	-30 °C
Max. ambient temperature	180 °C
Temperature resistance	Heat resistant
Temporary ambient temperature (<30 s) min.	-50 °C
Temporary ambient temperature (<30 s) max.	220 °C
Compressed air connection	G 1/4
external diameter	30 mm
Holding force	13.6 N
Separation force	39.6 N
Volume	4.75 cm ³
Max. curving on object R min	40 mm
Abrasion value according to DIN 535 16	180-200 mm ³
Hardness according to standard	55 ± 5 Shore A
Connection thread type	External thread
Material connector	Aluminum
Suction unit material	Fluoromethyl silicone
Delivery unit	1 piece
Weight	0.016 kg

Bellow suction gripper, BSG series

2024-03-15

1820415041

Part No.

1820415041

Technical information

To be used on uneven, sensitive, and smooth to slightly rough surfaces.

Dimensions

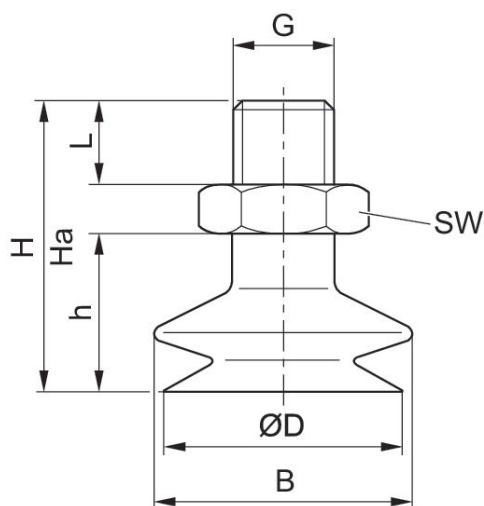

Part No.	ØD [mm]	G	Ha*)	H	h	B	SW	L
1820415029	10.4	G 1/8	25.5	29.5	16	12	14	7.5
1820415033	15.6	G 1/8	25.5	32.5	19	17	14	7.5
1820415037	20	G 1/8	27.5	32.5	19	24	14	7.5
1820415041	30	G 1/4	33	42	27	36	17	11
1820415045	38	G 1/4	33	43	28	46	17	11
1820415049	50	G 1/4	37	49	34	59	17	11
1820415053	74	G 1/4	50	64	47	83	21	11

*) Height for vacuum operation