

Tie rod cylinder, CNOMO NFE 49-001, Series C12P

7472403842

General series information
AVENTICS Series C12P Tie rod cylinders

- The AVENTICS Series C12P is a cylinder Series according the standard CNOMO NFE 49-001 and offer a replacement for existing application.

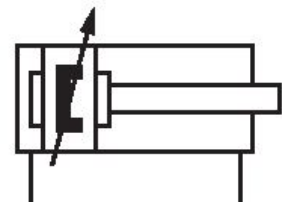

Technical data

Industry	Industrial
Standards	CNOMO / NFE 49-001
Piston Ø	40 mm
Stroke	450 mm
Ports	G 1/4
Functional principle	Double-acting
Cushioning	Pneumatic adjustable cushioning
Magnetic piston	Piston with magnet
Environmental requirements	Industry standard
Piston rod	single
Scraper	Standard Industry Scraper
Pressure for determining piston forces	6,3 bar

Retracting piston force	600 N
Extracting piston force	792 N
Min. ambient temperature	-20 °C
Max. ambient temperature	80 °C
Working pressure min.	2 bar
Working pressure max	10 bar
Piston rod thread	M16x1,5
Weight 0 mm stroke	0.75 kg
Weight +10 mm stroke	0.055 kg
Stroke max.	1900 mm
Medium	Compressed air
Min. medium temperature	-20 °C
Max. medium temperature	80 °C
Max. particle size	50 µm
Oil content of compressed air min.	0 mg/m ³
Oil content of compressed air max.	5 mg/m ³

Material

Piston rod	Stainless Steel
Material tie-rod	Stainless Steel
Seal material	Polyurethane
Material, front cover	Aluminum
Cylinder tube	Aluminum
End cover	Aluminum
Nut for piston rod	Steel, chrome-plated
Part No.	7472403842

Technical information

You will find the order key and all valid configurations (customer information) in the Media Centre.

The pressure dew point must be at least 15 °C less than ambient and medium temperature and may not exceed 3 °C.

The oil content of compressed air must remain constant during the life cycle.

Use only the approved oils from AVENTICS. Further information can be found in the "Technical information" document (available in <https://www.emerson.com/en-us/support>).

Dimensions

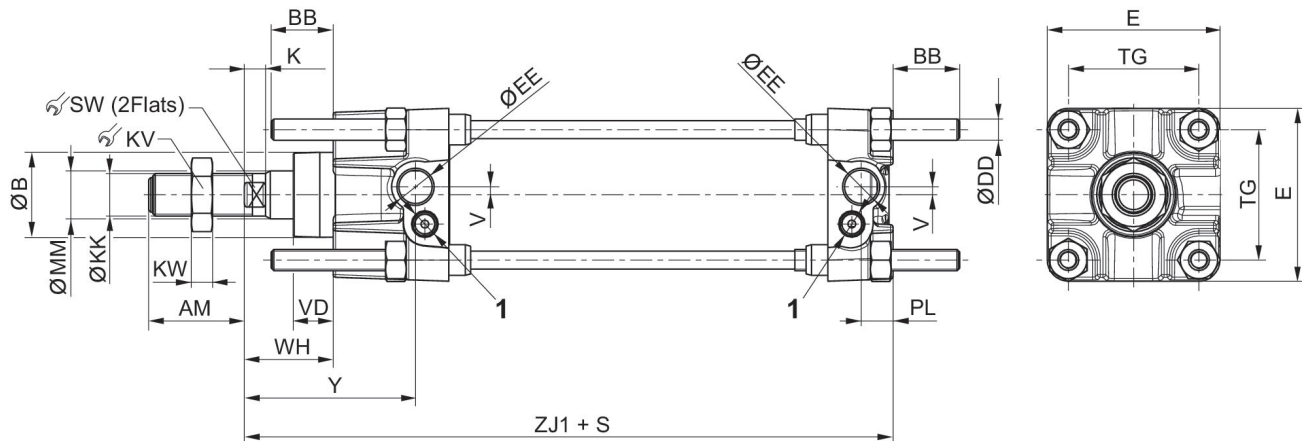

1) Flow control screw
S=stroke

Piston Ø	AM	BB	Ø B e9	Ø DD	E	Ø EE	K	Ø KK	KV
32	20	17	25	M6	45	G1/8	6	M10x1,5	17
40	36	17	32	M6	52	G1/4	8	M16x1,5	24
50	36	23	32	M8	65	G1/4	8	M16x1,5	24
63	46	23	45	M8	75	G3/8	10	M20x1,5	30
80	46	28	45	M10	95	G3/8	10	M20x1,5	30
100	63	28	55	M10	115	G1/2	16	M27x2	41
125	63	34	55	M12	140	G1/2	16	M27x2	41
160	85	42	65	M16	180	G3/4	16	M36x2	55
200	85	42	65	M16	220	G3/4	16	M36x2	55

Piston Ø	KW	Ø MM	PL	SW	TG	V	VD	WH	Y
32	5	12	9	8	33	-	15	25	44
40	8	18	12	13	40	3	15	34	65
50	8	18	12	13	49	3	15	34	65
63	10	22	14	17	59	5	20	39	71
80	10	22	14	17	75	9	20	39	71
100	13.5	30	18	22	90	-	20	47	84
125	13.5	30	18	22	110	-	20	47	84
160	18	40	25	32	140	-	25	50	95
200	18	40	25	32	175	-	25	50	95

Piston Ø	ZJ1
32	105
40	144
50	144
63	164
80	164
100	192

Piston Ø	ZJ1
125	192
160	230
200	230

Cushioning diagram



v = Piston velocity [m/s] m = Cushionable mass [kg]

Cushioning diagram



v = Piston velocity [m/s] m = Cushionable mass [kg]