

Tie rod cylinder, CNOMO NFE 49-001, Series C12P

R422715120

General series information
AVENTICS Series C12P Tie rod cylinders

- The AVENTICS Series C12P is a cylinder Series according the standard CNOMO NFE 49-001 and offer a replacement for existing application.

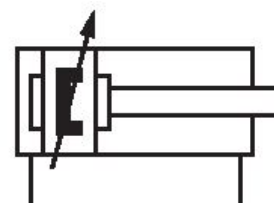
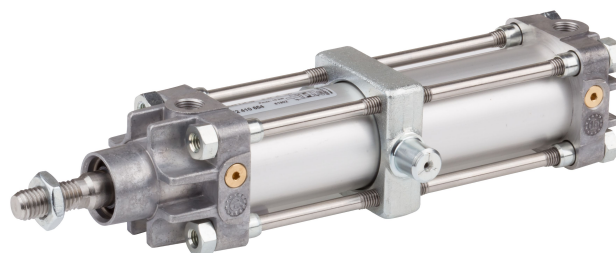

Technical data

Industry	Industrial
Standards	CNOMO / NFE 49-001
Piston Ø	200 mm
Stroke	50 mm
Ports	G 3/4
Functional principle	Double-acting
Cushioning	Pneumatic adjustable cushioning
Magnetic piston	Piston with magnet
Environmental requirements	Industry standard
Piston rod	single
Cylinder special features	with trunnion mounting
Scraper	Standard Industry Scraper

Pressure for determining piston forces	6,3 bar
Retracting piston force	19000 N
Extracting piston force	19792 N
Min. ambient temperature	-20 °C
Max. ambient temperature	80 °C
Working pressure min.	2 bar
Working pressure max	10 bar
Piston rod thread	M36x2
Weight 0 mm stroke	14.5 kg
Weight +10 mm stroke	0.54 kg
Stroke max.	2600 mm
Medium	Compressed air
Min. medium temperature	-20 °C
Max. medium temperature	80 °C
Max. particle size	50 µm
Oil content of compressed air min.	0 mg/m ³
Oil content of compressed air max.	5 mg/m ³

Material

Piston rod	Stainless Steel
Material tie-rod	Stainless Steel
Seal material	Polyurethane
Material, front cover	Aluminum
Cylinder tube	Aluminum
End cover	Aluminum
Nut for piston rod	Steel, chrome-plated
Part No.	R422715120

Technical information

Optional heat-resistant variants are suitable for applications at temperatures up to [[120]°C] and do not have a magnetic piston.

You will find the order key and all valid configurations (customer information) in the Media Centre.

The pressure dew point must be at least 15 °C less than ambient and medium temperature and may not exceed 3 °C.

The oil content of compressed air must remain constant during the life cycle.

Use only the approved oils from AVENTICS. Further information can be found in the "Technical information" document (available in <https://www.emerson.com/en-us/support>).

Dimensions

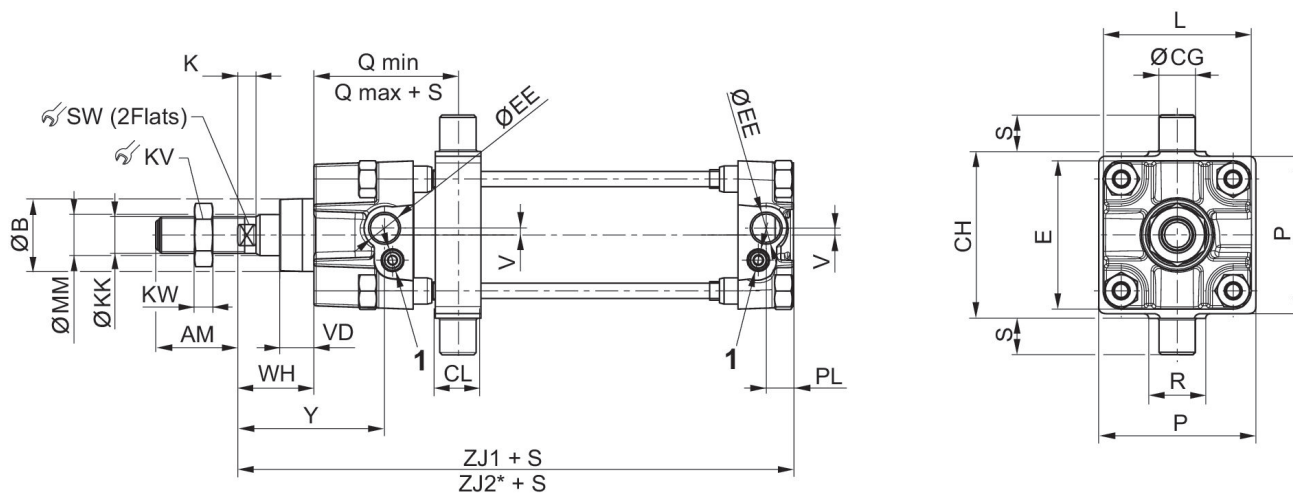

1) Flow control screw
S=stroke

Piston Ø	AM	Ø B e9	Ø CG	CH	CL	E	Ø EE	K	Ø KK
25	20	25	12	42	22	40	G1/8	6	M10x1,5
32	20	25	12	50	15	45	G1/8	6	M10x1,5
40	36	32	16	63	20	52	G1/4	8	M16x1,5
50	36	32	16	73	20	65	G1/4	8	M16x1,5
63	46	45	20	90	25	75	G3/8	10	M20x1,5
80	46	45	20	108	25	95	G3/8	10	M20x1,5
100	63	55	25	131	30	115	G1/2	16	M27x2
125	63	55	25	160	32	140	G1/2	16	M27x2
160	85	65	32	200	50	180	G3/4	16	M36x2
200	85	65	32	250	50	220	G3/4	16	M36x2

Piston Ø	KV	KW	Ø MM	P	PL	Q min.	Q max. + S	R	S
25	17	5	12	38	9	40	50	20	12
32	17	5	12	46	9	43	48	20	12
40	24	8	18	59	12	54	75	25	16
50	24	8	18	69	12	62	67	25	16
63	30	10	22	84	14	64	79	30	20
80	30	10	22	102	14	67	77	30	20
100	41	13.5	30	125	18	73	91	36	25
125	41	13.5	30	155	18	75	89	36	25
160	55	18	40	-	25	81	100	45	32
200	55	18	40	-	25	79	101	45	32

Piston Ø	SW	TG	V	VD	WH	Y	ZJ1	ZJ2
25	8	28	-	15	25	44	105	-
32	8	33	-	15	25	44	105	128
40	13	40	3	15	34	65	144	165

Piston Ø	SW	TG	V	VD	WH	Y	ZJ1	ZJ2
50	13	49	3	15	34	65	144	167
63	17	59	5	20	39	71	164	189
80	17	75	9	20	39	71	164	188
100	22	90	-	20	47	84	192	221
125	22	110	-	20	47	84	192	237
160	32	140	-	25	50	95	230	272
200	32	175	-	25	50	95	230	277

Cushioning diagram

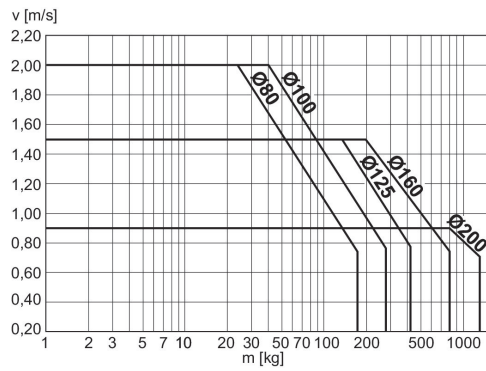

v = Piston velocity [m/s] m = Cushionable mass [kg]

Cushioning diagram

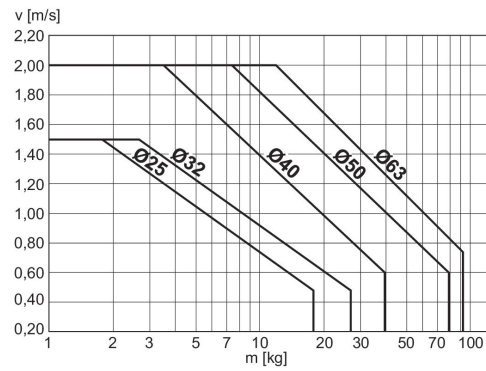

v = Piston velocity [m/s] m = Cushionable mass [kg]