

Bearing block, Series AB7

R422003605

Bearing
block

2023-11-14

AVENTICS Bearing blocks



Technical data

Industry

Industrial

Standardization

CNOMO / NFE 49-001

Piston diameter

100 mm

125 mm

Swivel bearing Ø

10 mm

Material

Housing material

Aluminum

Surface housing

Cathodic dip-painted

Part No.

R422003605

Dimensions

Bearing block, Series AB7

R422003605

Bearing
block

2023-11-14

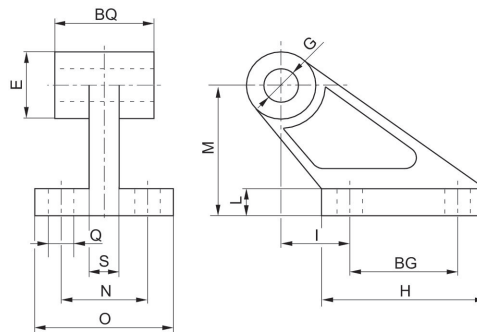

Piston Ø	Part No.	BG	BQ	G H9	H	I	L	M	N
25, 32	R422003602	20	20	8	37	18	8	32	25
40, 50	R422003603	32	32	12	54	25	10	45	32
63, 80	R422003604	50	50	16	75	32	13	63	40
100, 125	R422003605	70	70	20	103	40	17	90	50
160, 200	R422003606	110	110	25	154	50	20	140	63

Piston Ø	O	Q H13	R max.	S
25, 32	41	7	19.5	9
40, 50	52	9	26	14
63, 80	63	11	32	14
100, 125	80	14	42	22
160, 200	111	18	54	26