

Flange mounting, Series MF1, MF2

1827005932

Flange
mountings

2023-11-14

AVENTICS Flange mountings



Technical data

Industry

Industrial

Piston diameter

100 mm

Swivel bearing Ø

30 mm

Material

Housing material

Steel, chrome-plated

Surface housing

galvanized

Part No.

1827005932

Dimensions

Flange mounting, Series MF1, MF2

1827005932

Flange
mountings

2023-11-14

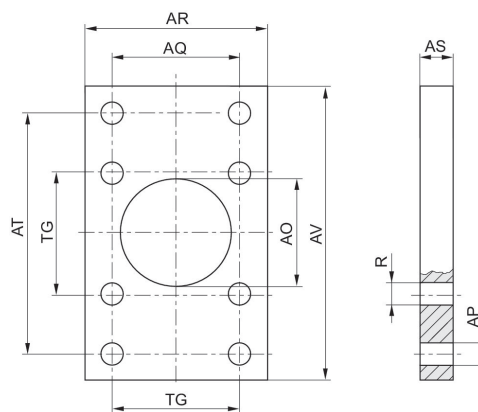

Piston Ø	Part No.	AO H11	AP H13	AQ JS14	AR	AS	AT JS14	AV	R
25	1827005926	25	9	28	40	8	68	80	7
32	1827005927	25	9	33	45	8	68	80	7
40	1827005928	32	9	40	52	8	78	90	7
50	1827005929	32	11	49	65	10	94	110	9
63	1827005930	45	11	59	75	10	104	120	9
80	1827005931	45	14	75	95	12	130	150	11
100	1827005932	55	14	90	115	12	150	170	11
125	1827005933	55	18	110	140	16	180	205	14
160	7472ZZ1408	65	22	140	180	20	228	260	18
200	7472ZZ1409	65	22	175	220	20	268	300	18

Piston Ø	TG
25	28
32	33
40	40
50	49
63	59
80	75
100	90
125	110
160	140
200	175