

Foot mounting, Series MS1

1827005882

Foot
mountings

2024-08-29

AVENTICS Foot mountings



Technical data

Industry

Industrial

Version

narrow version

Standardization

CNOMO / NFE 49-001

Piston diameter

63 mm

Material

Material

Aluminum

Surface

Cathodic dip-painted

Part No.

1827005882

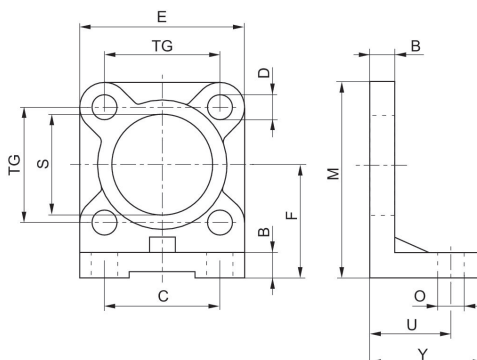

Foot mounting, Series MS1

1827005882

Foot
mountings

2024-08-29

Piston Ø	Part No.	B	C	D	E	F	M	O	S
25	1827005878	8	24	7	40	30	50	9	25
32	1827005879	8	28	7	45	32	54	9	25
40	1827005880	8	36	7	52	36	62	9	32
50	1827005881	10	45	9	65	45	77	11	32
63	1827005882	10	55	9	75	50	87	11	45
80	1827005883	12	70	11	95	63	110	14	45
100	1827005884	12	90	11	115	73	130	14	55
125	1827005885	16	110	14	140	91	161	18	55
160	7472ZZ1418	20	130	18	180	115	205	22	65
200	7472ZZ1419	20	170	18	220	135	245	22	65

Piston Ø	TG	U	Y
25	28	27	35
32	33	27	35
40	40	27	35
50	49	35	45
63	59	35	45
80	75	43	55
100	90	43	55
125	110	52	68
160	140	62	82
200	175	62	92