

Foot mounting, Series MS1

1827005874

Foot
mountings

2024-08-29

AVENTICS Foot mountings



Technical data

Industry

Industrial

Version

wide version

Standardization

CNOMO / NFE 49-001

Piston diameter

63 mm

Material

Material

Aluminum

Surface

Cathodic dip-painted

Part No.

1827005874

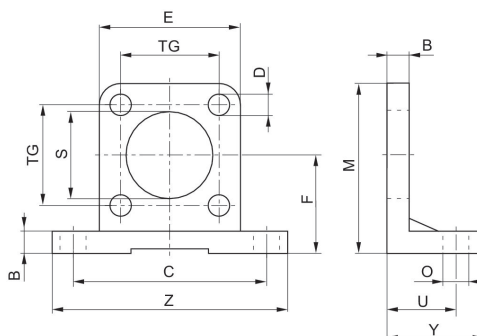

Foot mounting, Series MS1

1827005874

Foot
mountings

2024-08-29

Piston Ø	Part No.	B	C	D	E	F	M	O	S
25	1827005870	8	58	7	40	30	50	9	25
32	1827005871	8	65	7	45	32	54	9	25
40	1827005872	8	72	7	52	36	62	9	32
50	1827005873	10	90	9	65	45	77	11	32
63	1827005874	10	100	9	75	50	87	11	45
80	1827005875	12	126	11	95	63	110	14	45
100	1827005876	12	148	11	115	73	130	14	55
125	1827005877	16	180	14	140	91	161	18	55
160	7472ZZ1483	20	230	18	180	115	205	22	65
200	7472ZZ1484	20	270	18	220	135	245	22	65

Piston Ø	TG	U	Y	Z
25	28	18	35	75
32	33	18	35	82
40	40	18	35	90
50	49	22	45	110
63	59	22	45	120
80	75	28	55	154
100	90	28	55	180
125	110	32	67.5	215
160	140	40	80	275
200	175	40	80	318