

Sensor mounting, Series CB1

R412017979

General series information
AVENTICS Sensor mountings

- AVENTICS Sensors mountings are especially designed to mount AVENTICS sensors on various cylinders.

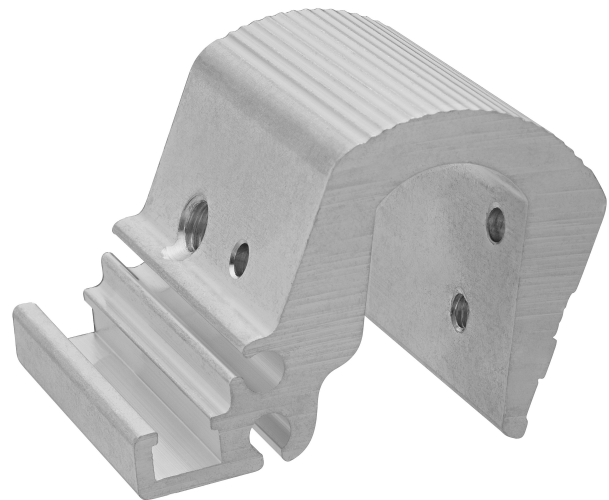

Technical data

Industry
for sensor

Industrial

ST6
SN2
SN6
SN1
SM6

For series

C12P
ITS

Cylinders \varnothing min.
Cylinders \varnothing max.
Weight

160 mm
200 mm
0.058 kg

Material

Housing material
Part No.

Aluminum
R412017979

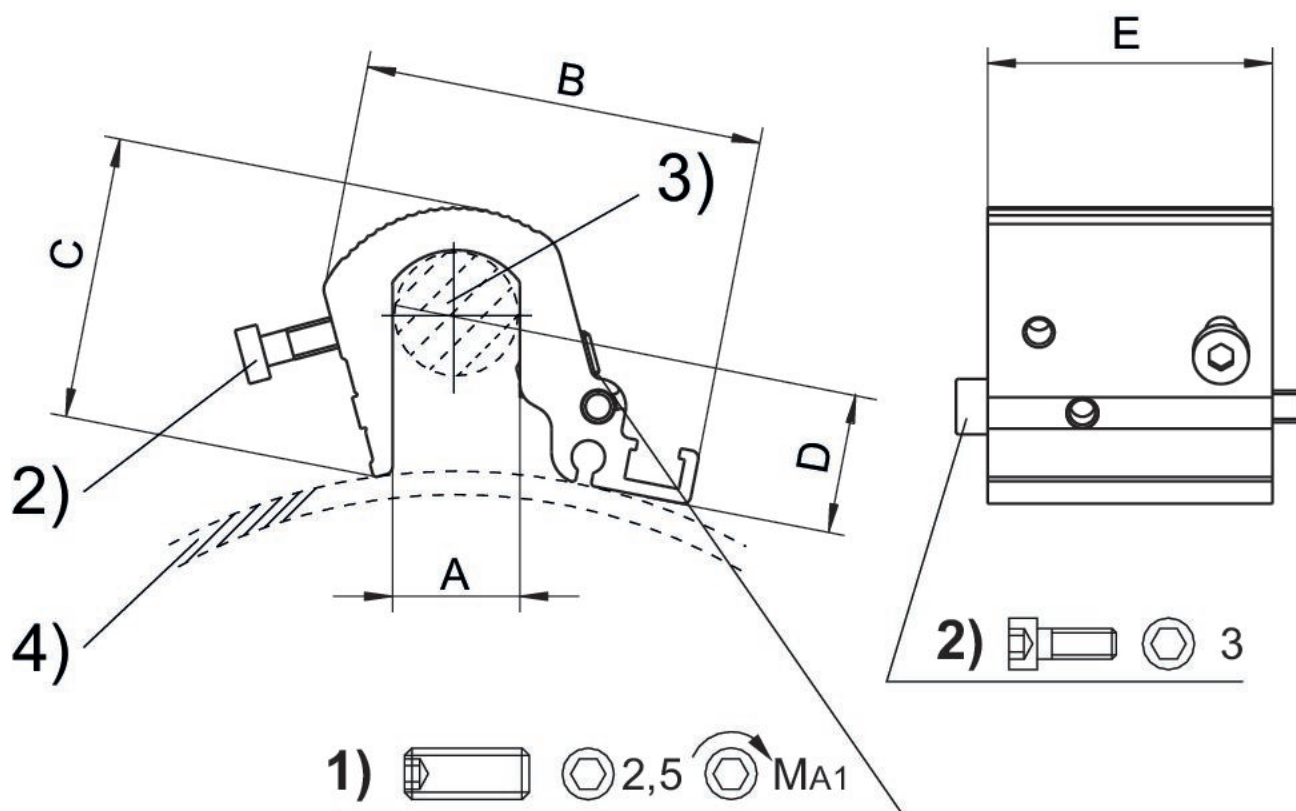

1) Clamping threaded pin 2) Mounting screws for sensor 3) Tie rod 4) Cylinder profile

Cylinders Ø	Part No.	A	B	C	D	E	MA1 [Nm]
160 - 200 mm	R412017979	16	51	36	6.8	36	2
250 - 320 mm	R412017980	24	56	44.5	6.8	36	2

Scope of delivery: Incl. mounting screws