

Sensor mounting, Series CB1

R412021792

General series information
AVENTICS Sensor mountings

- AVENTICS Sensors mountings are especially designed to mount AVENTICS sensors on various cylinders.



Technical data

Industry
For series

Industrial
MNI
ICM
CSL-RD

Min. ambient temperature
Max. ambient temperature
Cylinders Ø min.
Scope of delivery
Weight

-30 °C
80 °C
20 mm
1 piece
0.007 kg

Material

Housing material

Polyamide
Stainless Steel

Part No.

R412021792

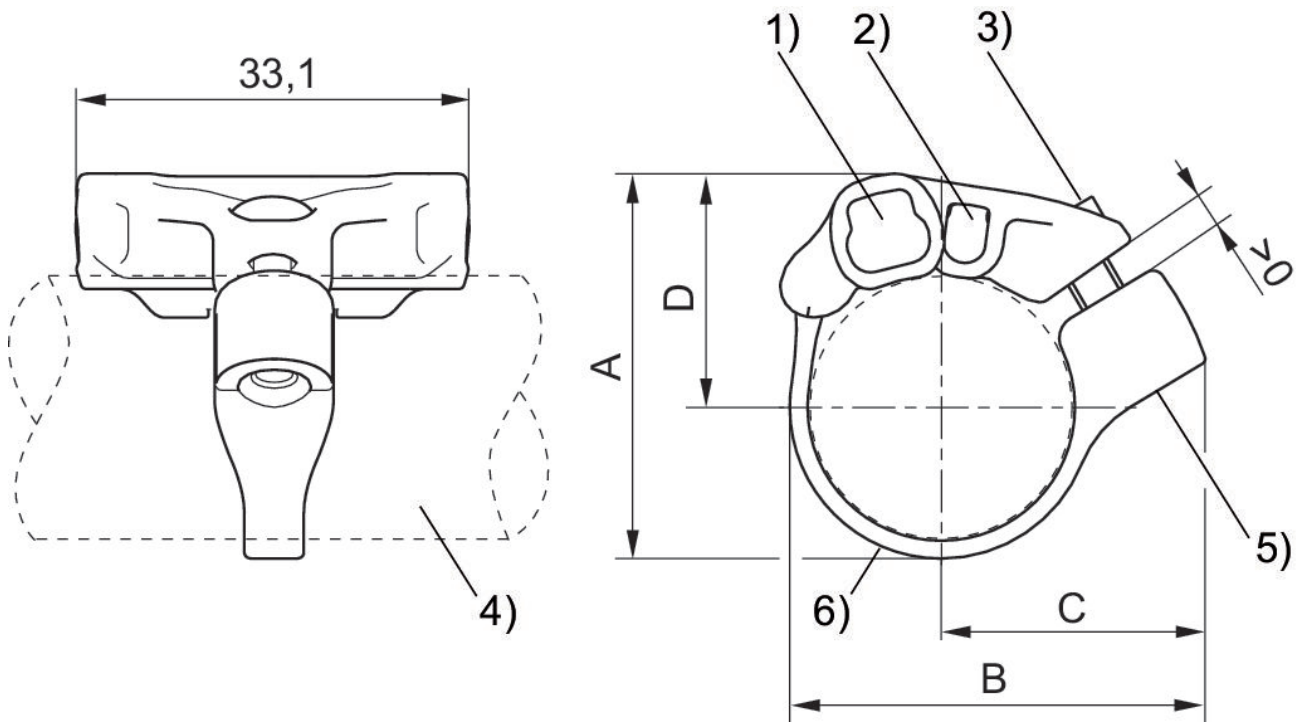

1) Sensor slot for ST6 2) Sensor slot for ST4 3) Mounting screw (made of stainless steel) 4) Cylinder profile 5) Thread insert (made of stainless steel) 6) Tightening strap

Part No.	A	B	C	D
R412021791	27.7	32.5	22.1	17.3
R412021792	32.4	35	22.4	19.7
R412021793	37.4	39.5	24.3	22.2