

Sensor mounting, Series CB1

R412025665

General series information
AVENTICS Sensor mountings

- AVENTICS Sensors mountings are especially designed to mount AVENTICS sensors on various cylinders.



Technical data

Industry	Industrial
For series	RPC
Cylinders Ø min.	32 mm
Cylinders Ø max.	32 mm
Weight	0.01 kg

Material

Housing material	Polyoxymethylene Aluminum
Part No.	R412025665

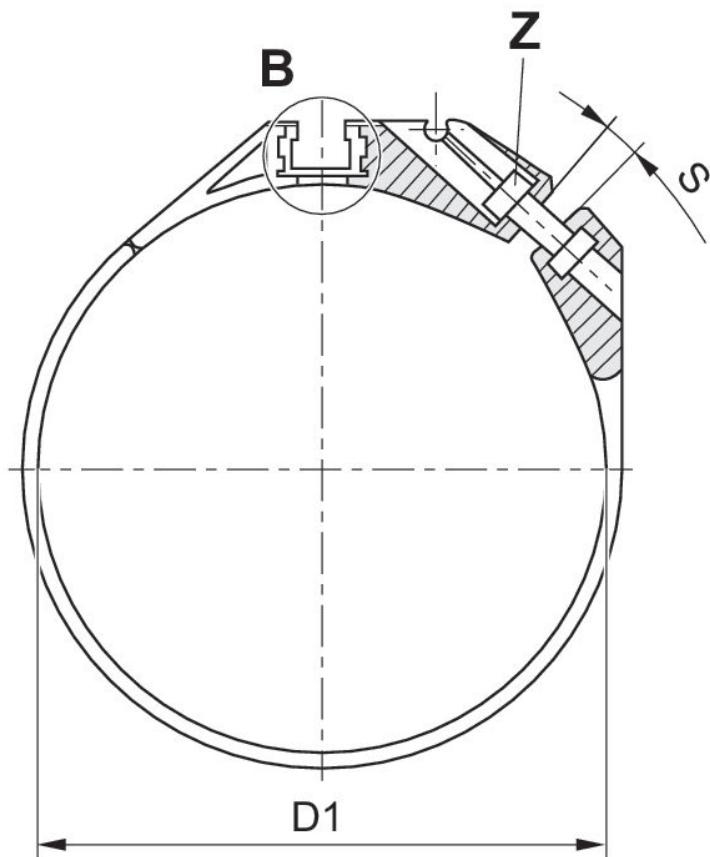

B 2 : 1

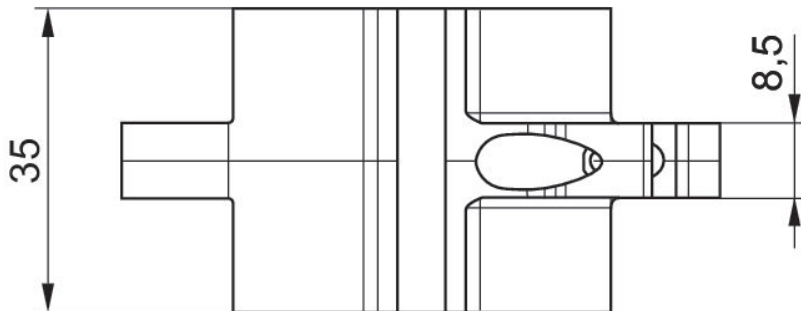
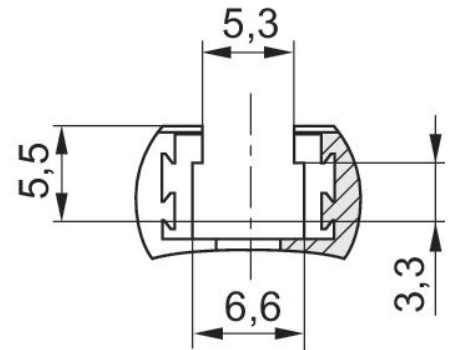

Part No.	D1	S	Z
R412025665	34	35	ISO 4762 - M3 x 10 A2
R412025666	42	43	ISO 4762 - M3 x 12 A2
R412025667	52,9	54	ISO 4762 - M3 x 12 A2
R412025668	65	66	ISO 4762 - M3 x 12 A2

S = recommended max. spread width [mm]