

Sensor mounting, Series CB1

1827020056

General series information
AVENTICS Sensor mountings

- AVENTICS Sensors mountings are especially designed to mount AVENTICS sensors on various cylinders.



Technical data

Industry	Industrial
For series	TRB
Cylinders Ø min.	32 mm
Cylinders Ø max.	40 mm
Weight	0.03 kg

Material

Housing material	Aluminum
Part No.	1827020056

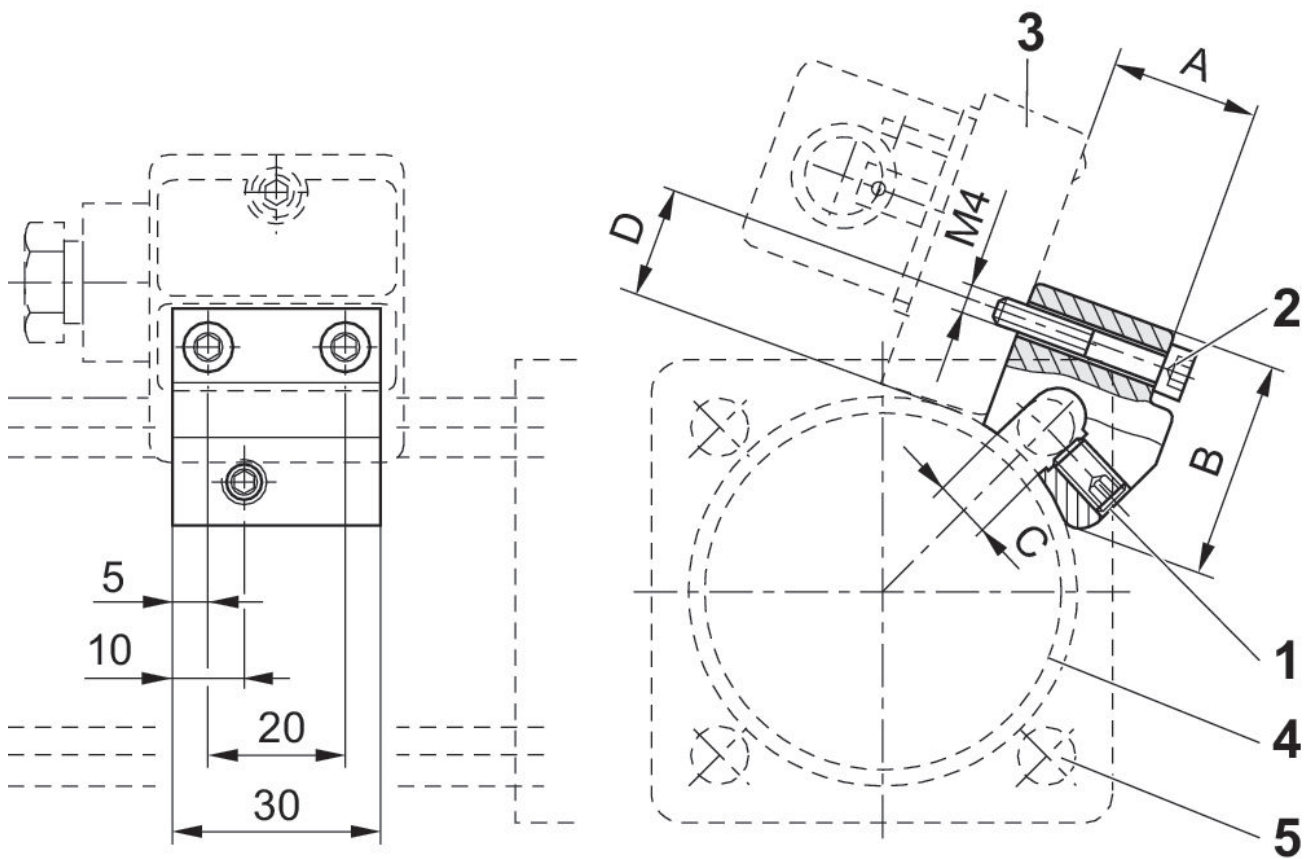

1) Clamping threaded pin 2) Mounting screw for sensor 3) Sensor 4) Cylinder profile 5) Tie rod

Part No.	A	B	C	D	SW
1827020056	19.5	30	6	15	3
1827020057	24.5	30	8	15	3
1827020058	29.5	31	10	15	3