

Sensor mounting, Series CB1

1827020284

General series information
AVENTICS Sensor mountings

- AVENTICS Sensors mountings are especially designed to mount AVENTICS sensors on various cylinders.



Technical data

Industry
For series

Industrial
TRB
C12P
167
CVI
TRR
523

Cylinders Ø min.
Cylinders Ø max.
Weight

80 mm
100 mm
0.042 kg

Material

Housing material
Part No.

Aluminum
1827020284

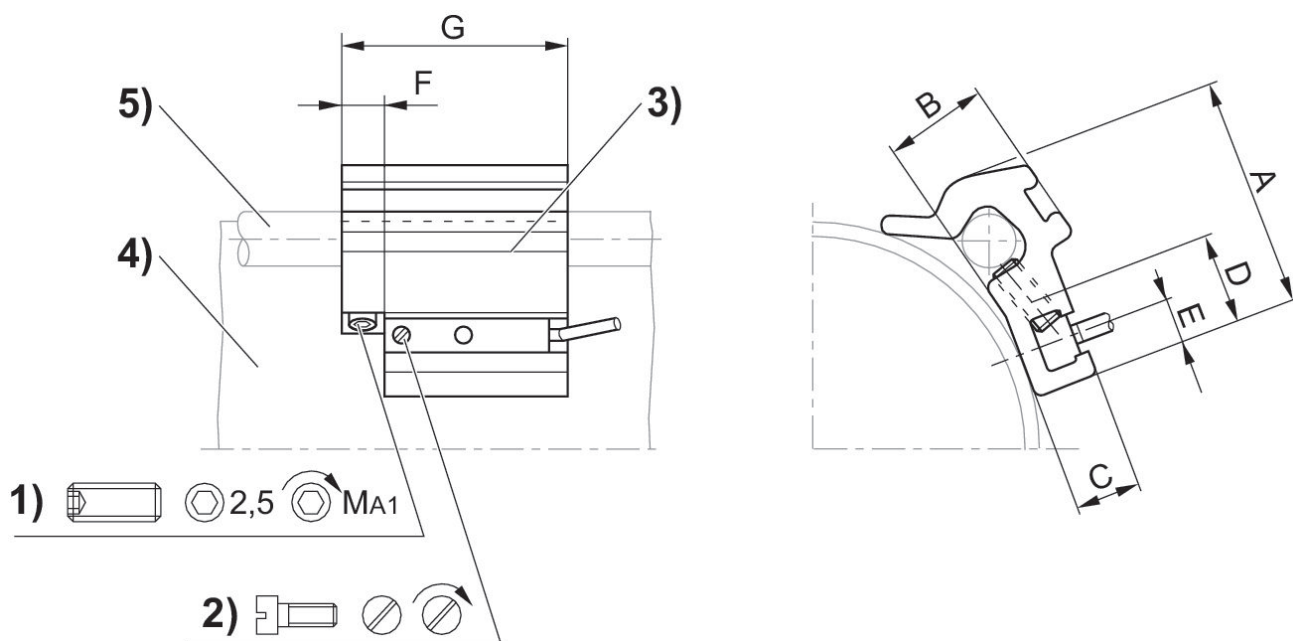

1) Clamping threaded pin 2) Mounting screw for sensor 3) Sensor 4) Cylinder profile 5) Tie rod

Part No.	Cylinders Ø	A	B	C	D	E	F	G	Clamping threaded pin
1827020282	32 - 40 mm	26	10	7	14	5	8	40	M5x8
1827020283	50 - 63 mm	32.5	15.5	7	14	5	8	40	M5x10
1827020284	80 - 100 mm	43	17	6.9	14	5	8	40	M5x16

Part No.	MA1 [Nm]
1827020282	2 ±0,2
1827020283	2 ±0,2
1827020284	2 ±0,2