

Sensor mounting, Series CB1

1827020076

General series information
AVENTICS Sensor mountings

- AVENTICS Sensors mountings are especially designed to mount AVENTICS sensors on various cylinders.

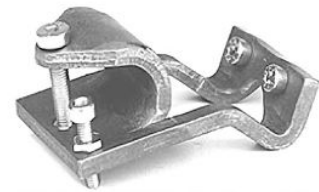

Technical data

Industry	Industrial
For series	TRB ITS
Cylinders Ø min.	125 mm
Cylinders Ø max.	125 mm
Weight	0.075 kg

Material

Housing material	Aluminum
Part No.	1827020076

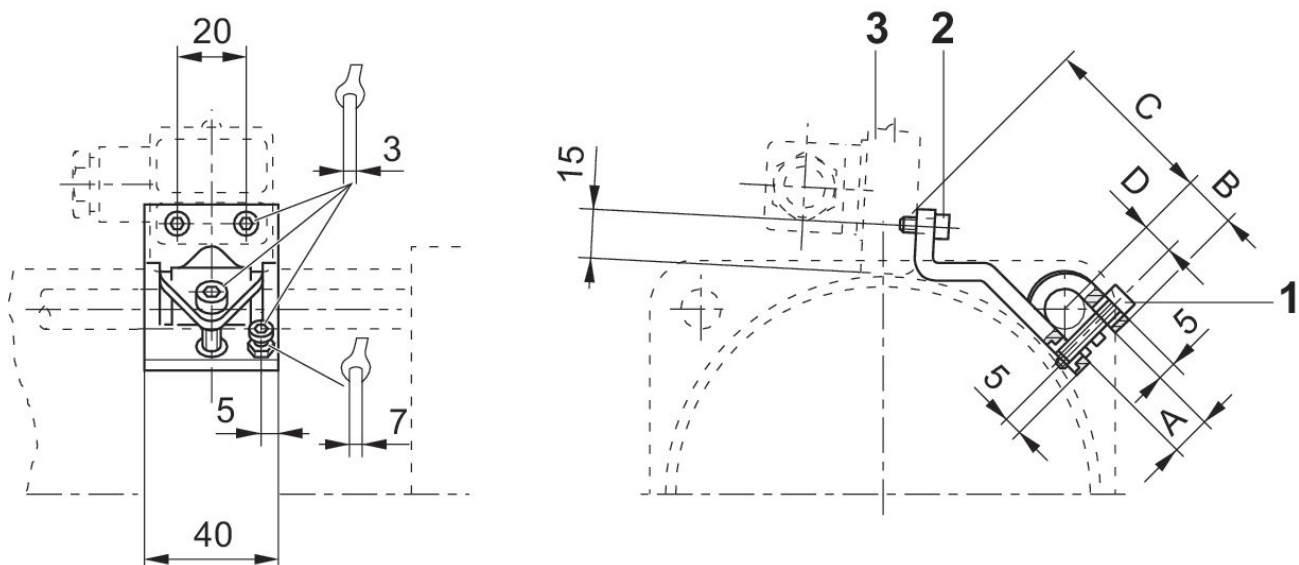

1) Mounting screw 2) Mounting screw for sensor 3) Sensor

Part No.	A +0,5	B ±1	C ±2	D
1827020076	12	15	54	9
1827020077	16	17	53	11
1827020078	20	19	60	13