

# Check-choke valve, Series CC02-AL

0821200248

## General series information

AVENTICS Series CC02 Check-choke valves

- The AVENTICS Series CC check-choke valves are designed for nominal flows from 50 to 1960 l/min. The different versions are available with a push-in fitting or internal thread.

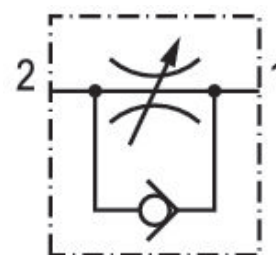

## Technical data

Industry	Industrial
Port 1	Ø 8
Port 2	G 3/8
Throttle bore Ø	6.6 mm
direction of throttle	2 > 1
Nominal flow Qn 2 to 1	900 l/min
Compressed air connection type 1	push-in fitting
Compressed air connection type 2	External thread
Throttle	Exhaust Air Throttling
Medium	Compressed air
Working pressure min.	0.5 bar
Working pressure max	10 bar
Min. ambient temperature	-10 °C

Max. ambient temperature 70 °C  
 Min. medium temperature -10 °C  
 Max. medium temperature 70 °C

## Material

Housing material Aluminum, anodized  
 Material flow control screw Brass  
 Seal material Acrylonitrile butadiene rubber  
 Part No. 0821200248

## Dimensions

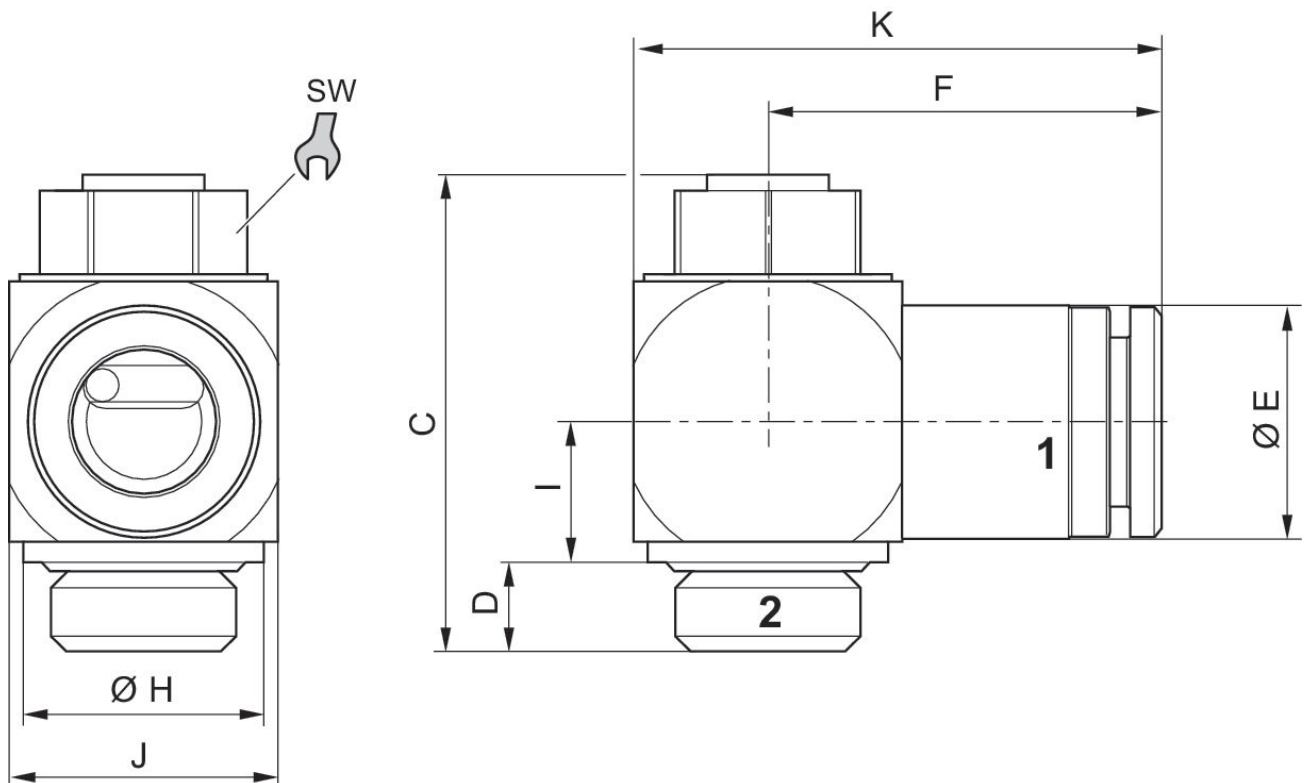

Part No.	Port 1	Port 2	C	D	ØE	F	ØH	I	J
R412027120	Ø 4	M5	21.8	3.9	10.45	16.9	8.5	6.3	10.5
R412004995	Ø 6	M5	21.8	3.9	10.45	16.9	8.5	6.3	10.5
0821200242	Ø 6	G 1/8	28.5	5.1	13	23.3	14	8	15
0821200246	Ø 6	G 1/4	33.6	6.2	16	25.8	17	9.8	19
0821200244	Ø 8	G 1/8	28.5	5.1	13.8	24.3	14	8	15
0821200247	Ø 8	G 1/4	33.6	6.2	16	26.2	17	9.8	19
0821200248	Ø 8	G 3/8	41	7.2	16	30.2	22	13.3	24

Part No.	Port 1	Port 2	C	D	ØE	F	ØH	I	J
0821200253	Ø 10	G 1/4	33.6	6.2	16	27.9	17	9.8	19
0821200249	Ø 10	G 3/8	41	7.2	19	30.9	22	13.3	24
R412007432	Ø 12	G 3/8	41	7.2	22	33	22	13.3	24

Part No.	K	SW
R412027120	21.7	7
R412004995	21.7	7
0821200242	30.3	10
0821200246	35.3	13
0821200244	31.2	10
0821200247	35.7	13
0821200248	42.7	16
0821200253	37.4	13
0821200249	43.4	16
R412007432	45.5	16