

Check-choke valve, Series CC02-AL

0821200243

General series information

AVENTICS Series CC02 Check-choke valves

- The AVENTICS Series CC check-choke valves are designed for nominal flows from 50 to 1960 l/min. The different versions are available with a push-in fitting or internal thread.

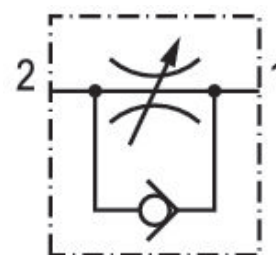

Technical data

Industry

Industrial

Port 1

Ø 6

Port 2

G 1/8

Throttle bore Ø

3.5 mm

direction of throttle

2 > 1

Nominal flow Q_n 2 to 1

360 l/min

Compressed air connection type 1

push-in fitting

Compressed air connection type 2

External thread

Throttle

Exhaust Air Throttling

Medium

Compressed air

Working pressure min.

0.5 bar

Working pressure max

10 bar

Min. ambient temperature

-10 °C

Max. ambient temperature	70 °C
Min. medium temperature	-10 °C
Max. medium temperature	70 °C

Material

Housing material	Aluminum, anodized
Material flow control screw	Brass
Seal material	Acrylonitrile butadiene rubber
Part No.	0821200243

Dimensions

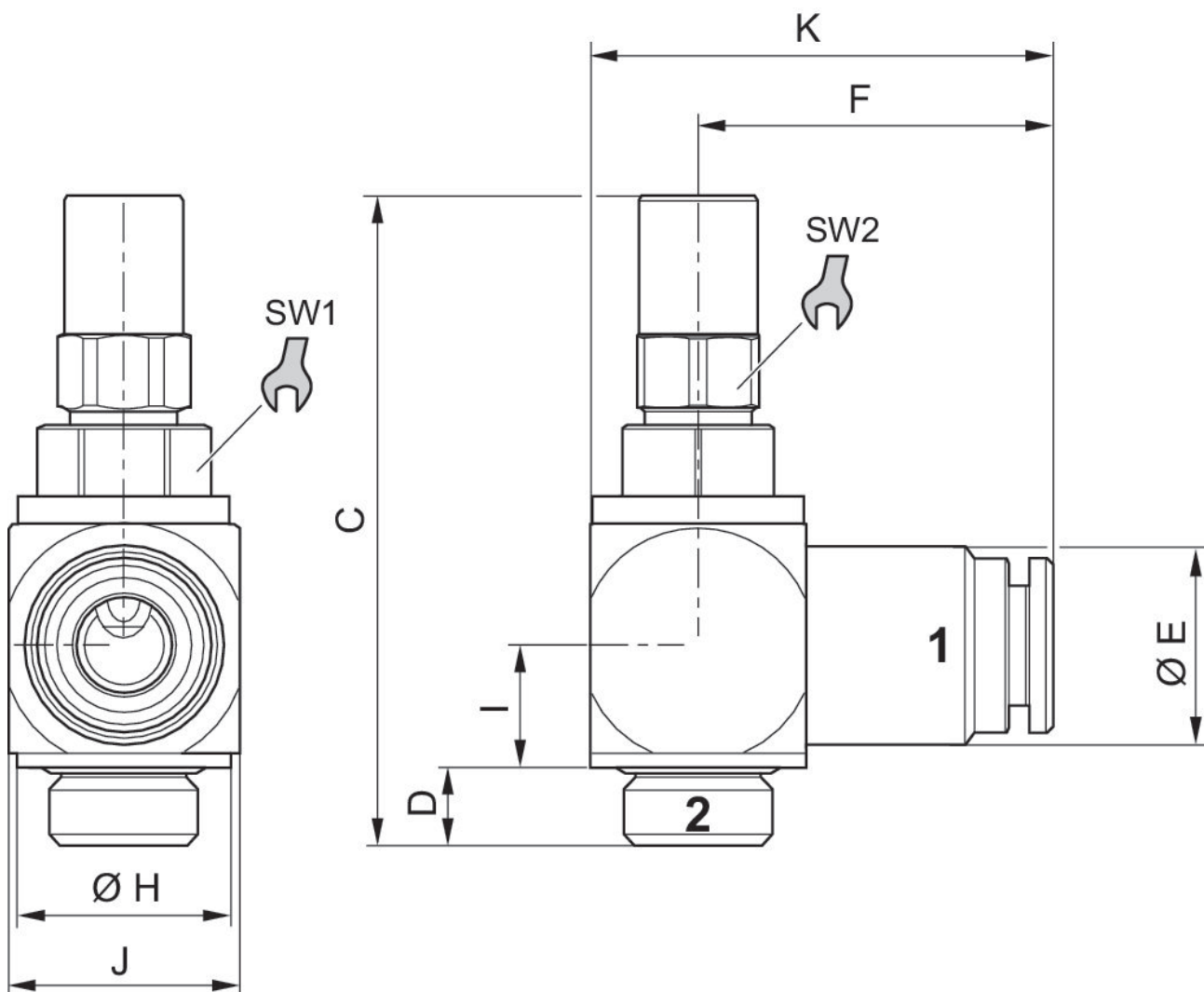

Part No.	Port 1	Port 2	C	D	ØE	F	ØH	I	J
0821200241	Ø 4	G 1/8	42.5	5.1	12	20.8	14	8	15
0821200243	Ø 6	G 1/8	42.5	5.1	13	23.3	14	8	15
0821200245	Ø 6	G 1/4	47.6	6.4	16	25.8	17	9.8	19

Part No.	K	SW1	SW2
0821200241	27.8	10	8
0821200243	30.3	10	8
0821200245	35.3	13	8