

# Check-choke valve, Series CC04

## R412010593

Series CC04

■  $Q_n = [[70] \text{ l/min}] \dots [[1950] \text{ l/min}]$

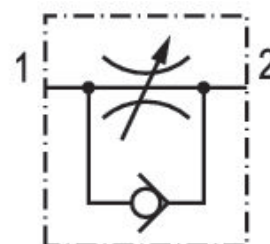

### Technical data

Industry  
Industrial

Port 1  
 $\varnothing 12$

Port 2  
G 3/8

Throttle bore  $\varnothing$   
6.6 mm

direction of throttle  
1 > 2

Nominal flow  $Q_n$  1 to 2  
1210 l/min

Compressed air connection type 1  
push-in fitting

Compressed air connection type 2  
External thread

Throttle  
Inlet-Side Throttling

Medium  
Compressed air

Working pressure min.  
0.5 bar

Working pressure max  
10 bar

Min. ambient temperature  
 $-10\text{ }^{\circ}\text{C}$

Max. ambient temperature  
 $60\text{ }^{\circ}\text{C}$

Min. medium temperature  
 $-10\text{ }^{\circ}\text{C}$

Max. medium temperature  
 $60\text{ }^{\circ}\text{C}$

## Material

Housing material

Polyamide

Seal material

Acrylonitrile butadiene rubber

Material compressed air connection

Brass

Part No.

R412010593

## Technical information

The min. control pressure must be adhered to, since otherwise faulty switching and valve failure may result!

The pressure dew point must be at least 15 °C under ambient and medium temperature and may not exceed 3 °C .

The oil content of compressed air must remain constant during the life cycle.

Use only the approved oils from AVENTICS. Further information can be found in the “Technical information” document (available in <https://www.emerson.com/en-us/support>).

## Dimensions

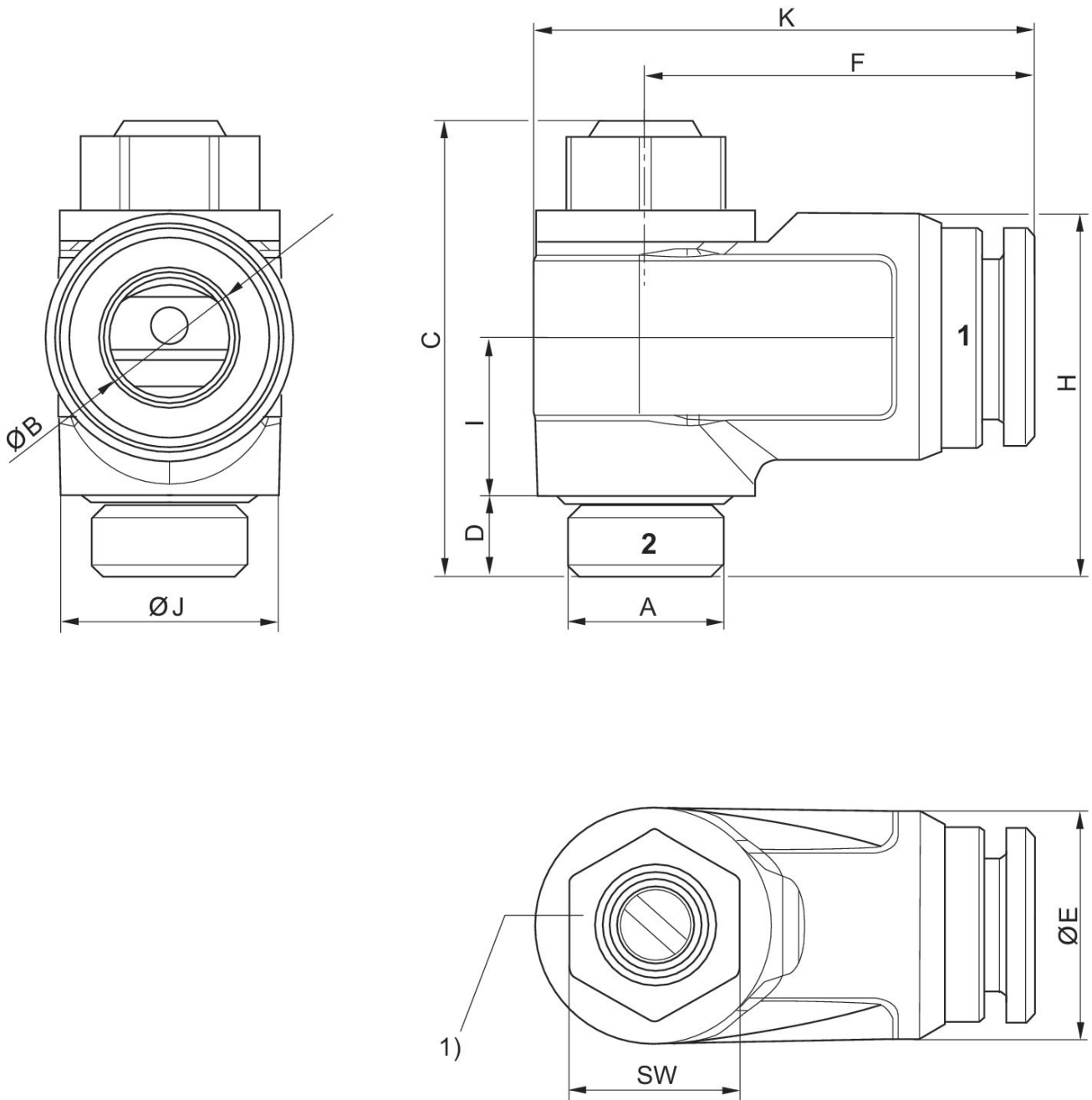

1) Recommended tightening torque  $M_A$ : M 5: 1.1 Nm -0.2 G 1/8: 3.0 Nm -0.3 G 1/4: 6.0 Nm -0.6 G 3/8: 8.0 Nm -1.0 G 1/2: 10.0 Nm -1.0

Part No.	Port 1	Port 2	$\varnothing B$	C	D	$\varnothing E$	F	K	H
R412010581	$\varnothing 4$	M5	4	21.8	4	9	15.9	20.4	12
R412010582	$\varnothing 6$	M5	6	21.8	4	11.1	17.2	21.8	13
R412010585	$\varnothing 4$	G 1/8	4	28.5	5.5	11.5	21.9	28.8	21
R412010586	$\varnothing 6$	G 1/8	6	28.5	5.5	13.5	22.4	29.3	21.7
R412010587	$\varnothing 8$	G 1/8	8	28.5	5.5	15.5	24.2	31.1	22.7

Part No.	Port 1	Port 2	Ø B	C	D	Ø E	F	K	H
R412010588	Ø 6	G 1/4	6	33.6	6.5	13	24.3	33.5	25.3
R412010589	Ø 8	G 1/4	8	33.6	6.5	15.5	26.6	35.5	25.3
R412010590	Ø 10	G 1/4	10	33.6	6.5	18.1	29.2	38.1	26.7
R412010591	Ø 8	G 3/8	8	40.8	7	15.6	28.2	40.6	23.6
R412010592	Ø 10	G 3/8	10	40.8	7	19	32	43.3	33.5
R412010593	Ø 12	G 3/8	12	40.8	7	22.1	34.2	45.4	35.6
R412010594	Ø 10	G 1/2	10	47.8	8.3	19.2	34	47.7	41.4
R412010595	Ø 12	G 1/2	12	47.8	8.3	22	36.1	49.8	43.9

Part No.	l	Ø J	SW
R412010581	7.5	8.7	7
R412010582	7.5	8.7	7
R412010585	9.8	13.6	10
R412010586	9.8	13.6	10
R412010587	9.8	13.6	10
R412010588	12.8	17.6	13
R412010589	11.5	17.6	13
R412010590	11.5	17.6	13
R412010591	15.8	22.2	16
R412010592	16.4	22.2	16
R412010593	17.8	22.2	16
R412010594	20.3	26.6	18
R412010595	21.5	26.6	18

Flow diagram  
Fig. 2

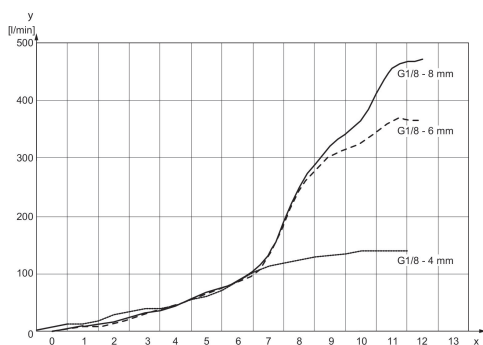

x = rotations of the throttle screw y = flow rate Qn

Flow diagram  
Fig. 3

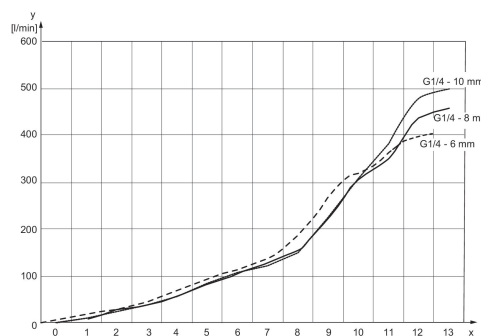

x = rotations of the throttle screw y = flow rate Qn

Flow diagram  
Fig. 4

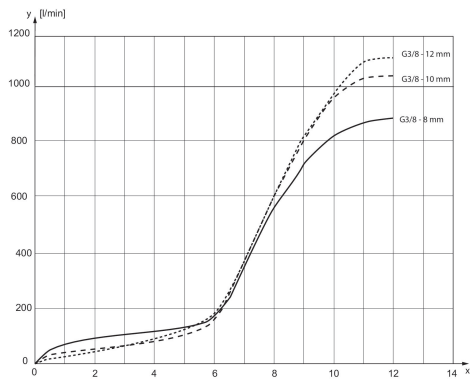

x = rotations of the throttle screw y = flow rate Qn

Flow diagram  
Fig. 5

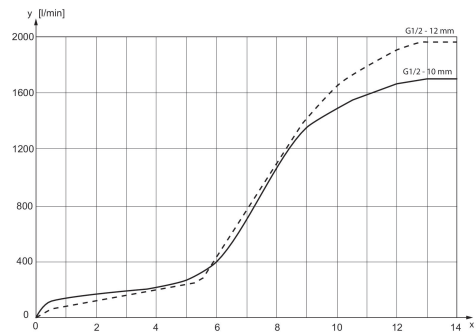

x = rotations of the throttle screw y = flow rate Qn

Flow diagram  
Fig. 1

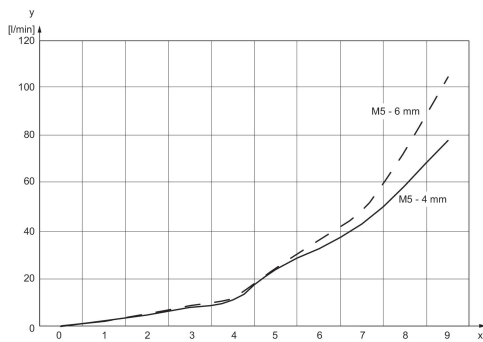

x = rotations of the throttle screw y = flow rate Qn