

AVENTICS Series CCI Compact cylinders (ISO 21287)

The AVENTICS Series CCI (ISO 21287) cylinders stand for innovative, compact construction and an easy to clean design. The Series CCI (ISO 21287) is ideal for long strokes and increased requirements for optimized cycle times and moving masses. The sensors can be installed quickly and easily on all sides and over the entire cylinder lengths.

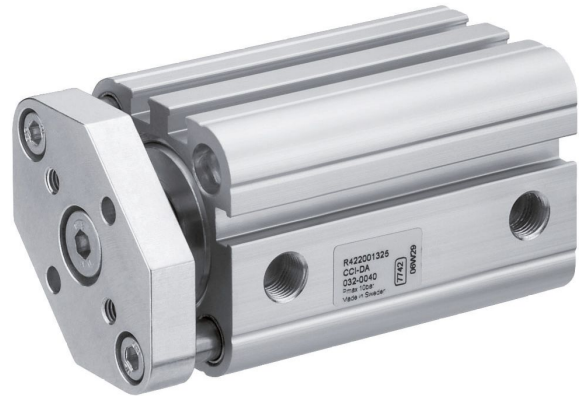

Technical data

Industry	Industrial
Standards	ISO 21287
Piston Ø	16 mm
Stroke	20 mm
Ports	M5
Functional principle	Double-acting
Cushioning	Elastic cushioning
Magnetic piston	Piston with magnet
Environmental requirements	Industry standard ATEX optional
Piston rod thread - type	Internal thread
Piston rod thread	M4
Piston rod	non-rotating, with front plate
Scraper	Standard Industry Scraper
Pressure for determining piston forces	6,3 bar
Retracting piston force	95 N
Extracting piston force	127 N
Min. ambient temperature	-20 °C
Max. ambient temperature	80 °C
Min. working pressure	1 bar

Compact cylinder ISO 21287, Series CCI

series CCI

R422001292

2023-11-23

Max. working pressure	10 bar
Impact energy	0.15 J
Weight 0 mm stroke	0.071 kg
Weight +10 mm stroke	0.019 kg
Stroke max.	300 mm
Medium	Compressed air
Min. medium temperature	-20 °C
Max. medium temperature	80 °C
Max. particle size	50 µm
Min. oil content of compressed air	0 mg/m ³
Max. oil content of compressed air	5 mg/m ³

Material

Piston rod	Stainless Steel
Scraper material	Polyurethane
Seal material	Polyurethane
Material, front cover	Aluminum
Cylinder tube	Aluminum
End cover	Aluminum
Front plate	Aluminum
Nut for piston rod	Steel, chrome-plated
Part No.	R422001292

Technical information

The pressure dew point must be at least 15 °C less than ambient and medium temperature and may not exceed 3 °C.

The oil content of compressed air must remain constant during the life cycle.

Use only the approved oils from AVENTICS. Further information can be found in the “Technical information” document (available in <https://www.emerson.com/en-us/support>).

Compact cylinder ISO 21287, Series CCI

series CCI

R422001292

2023-11-23

Dimensions

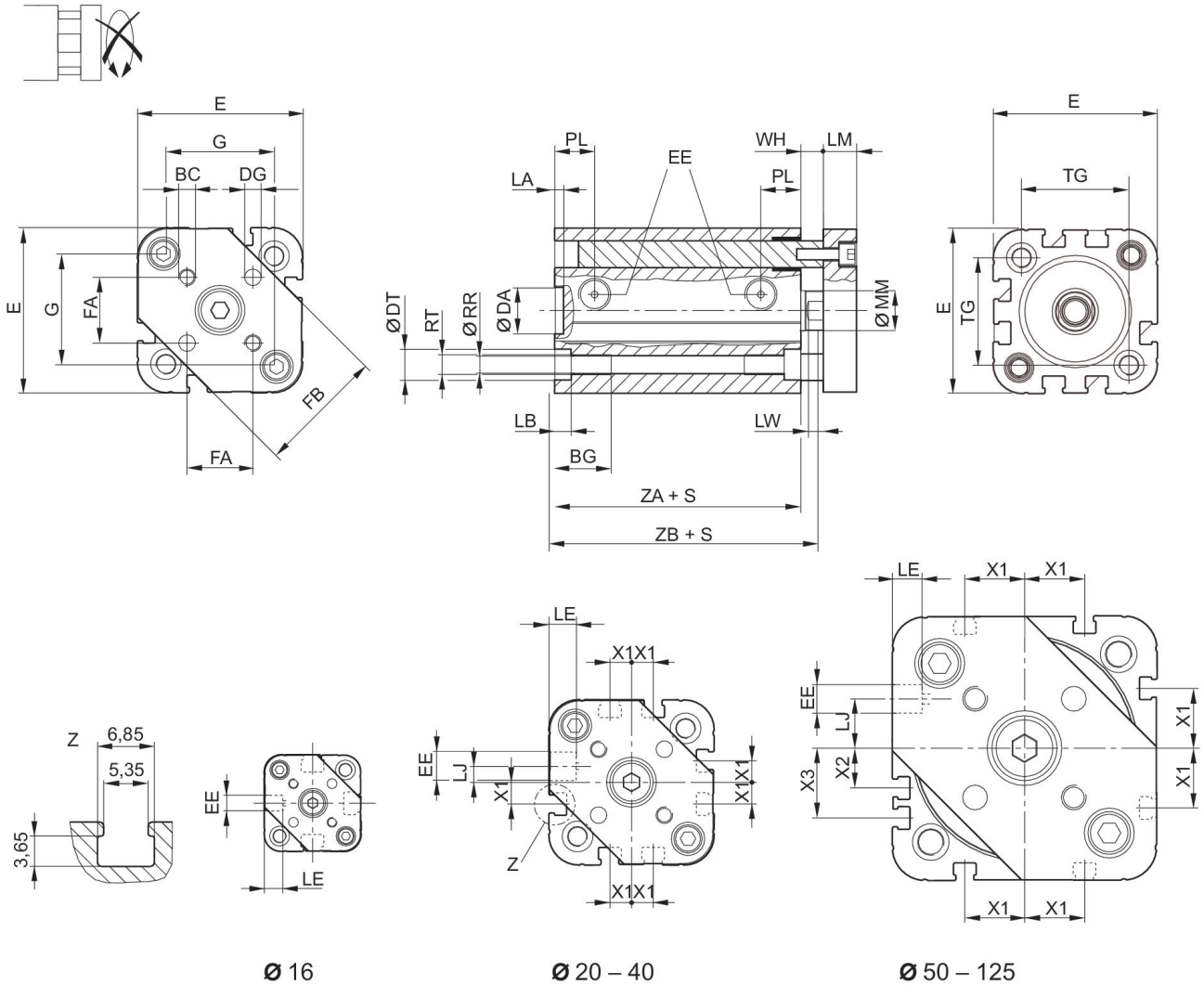

S = stroke

G = distance between the guide rods

Piston \varnothing	BC	BG	DA H11	DG H13	DT	E	EE	FA	FB
16	M3	15	10	3	6	29.3	M5	9.9 ±0.1	20
20	M4	15.5	12	4	7.5	36.3	M5	12 ±0.1	24
25	M5	15.5	12	5	8	40.3	M5	15.6 ±0.1	30
32	M5	17	14	5	8.6	50	G 1/8	19.8 ±0.1	38
40	M5	17	14	5	9.2	58	G 1/8	23.3 ±0.1	44
50	M6	17	18	6	11	68.3	G 1/8	29.7 ±0.1	54
63	M6	17	18	6	11	80	G 1/8	35.4 ±0.1	62
80	M8	20	23	8	15	96	G 1/8	46 ±0.1	80
100	M10	20	28	10	15	116	G 1/8	56.6 ±0.1	100
125	M10	35	12	10	-	134.6	G 1/4	63.64 ±0.1	120

Piston Ø	G	LA	LB	LE	LJ	LM	LW	MM f8	PL
16	19	2.5	3.5	4.5	–	6	4	8	8
20	25	2.5	4.5	4.5	4.5	8	4	10	10
25	27	2.5	4.5	4.5	4	8	4	10	10
32	34	2.5	5	7.5	4.85	10	4.5	12	12
40	42	2.5	5	7.5	9.85	10	4.5	12	12
50	49	2.5	5	7.5	12	12	6	16	12
63	60	2.5	5	7.5	14.8	12	6	16	12
80	72	3	5	7.5	22	14	7	20	14
100	92	3	5	7.5	27	14	7	25	16.5
125	110	2.6	-	???	39	18	7.5	25	20.5

Piston Ø	RR	RT 6H	TG	WH	X1	X2	X3	ZA ±0,1	ZB
16	3.3	M4	18	4.8 ±0.9	–	–	–	34.9	39.7 ±0.8
20	4.2	M5	22	5.6 ±0.9	4.2	–	–	37.3	43.6 ±0.8
25	4.2	M5	26	5.6 ±0.9	4.5	–	–	39	44.5 ±0.9
32	5.1	M6	32.5	7.4 ±0.9	6.5	–	–	44	51.4 ±1
40	5.1	M6	38	7.4 ±0.9	11	–	–	45	52.4 ±1
50	6.7	M8	46.5	8.4 ±0.9	13	4	13	45.5	53.6 ±1
63	6.7	M8	56.5	8.5 ±0.9	18	12	21	49	57.4 ±1
80	8.5	M10	72	9.8 ±1	18	16.5	25.5	54.7	64.4 ±1
100	8.5	M10	89	9.8 ±1	20	20	29	67	76.7 ±1
125	11.1	M12	110	11	29	29	38	81	92 ±1

Maximum admissible lateral force dynamic

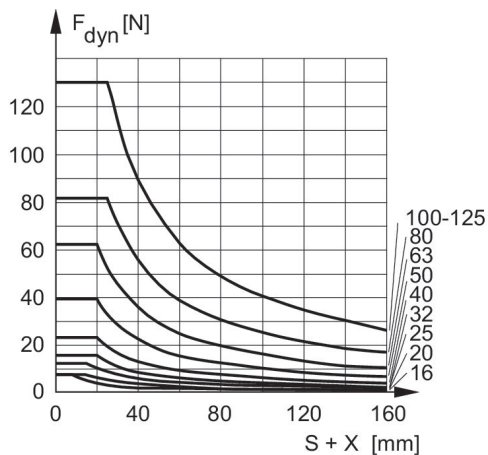

F_{dyn} = dynamic lateral force
 X = distance between force application point and cylinder cover
 S = stroke

Maximum admissible lateral force dynamic

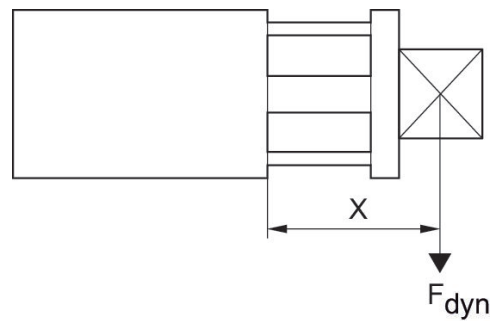

F_{dyn} = dynamic lateral force
 X = distance between force application point and cylinder cover

Maximum admissible lateral force static

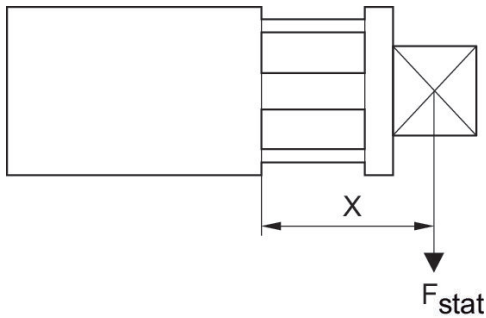

F_{stat} = static lateral force
 X = distance between force application point and cylinder cover

Maximum admissible lateral force static

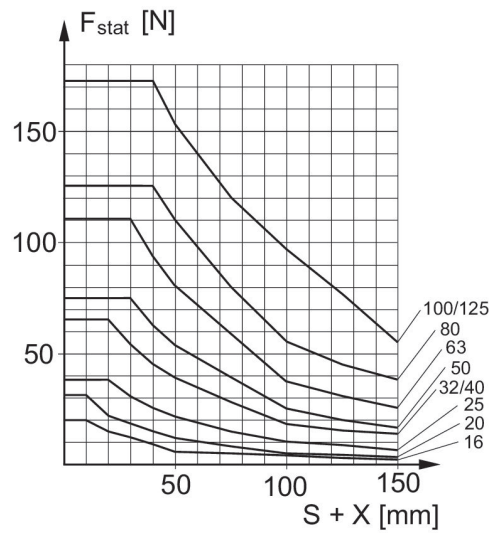

F_{stat} = static lateral force
 X = distance between force application point and cylinder cover
 S = stroke

Max. permissible torque

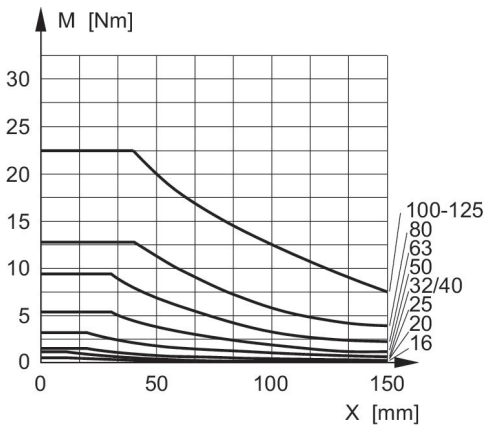

M = max. permissible torque
 X = spacing between torque contact surface and cylinder cover

Max. permissible torque

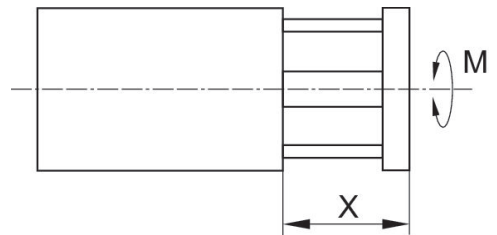

M = max. permissible torque
 X = distance between force application point and cylinder cover

Overview drawing



NOTE: This overview drawing is only for orientation to indicate where the various accessory parts can be fastened to the cylinder. The illustration has been simplified for this purpose. It is thus not possible to derive the dimensions from this overview.