

AVENTICS Series CCI Compact cylinders (ISO 21287)

The AVENTICS Series CCI (ISO 21287) cylinders stand for innovative, compact construction and an easy to clean design. The Series CCI (ISO 21287) is ideal for long strokes and increased requirements for optimized cycle times and moving masses. The sensors can be installed quickly and easily on all sides and over the entire cylinder lengths.



Technical data

| | |
|--|------------------------------------|
| Industry | Industrial |
| Standards | ISO 21287 |
| Piston Ø | 100 mm |
| Stroke | 5 mm |
| Ports | G 1/8 |
| Functional principle | Double-acting |
| Cushioning | Elastic cushioning |
| Magnetic piston | Piston with magnet |
| Environmental requirements | Industry standard ATEX optional |
| Piston rod thread - type | External thread |
| Piston rod thread | M16x1,5 |
| Piston rod | single |
| Scraper | Standard Industry Scraper |
| Pressure for determining piston forces | 6,3 bar |
| Retracting piston force | 4639 N |
| Extracting piston force | 4948 N |
| Min. ambient temperature | -20 °C |
| Max. ambient temperature | 80 °C |
| Min. working pressure | 1 bar |

| | |
|------------------------------------|---------------------|
| Max. working pressure | 10 bar |
| Impact energy | 2.5 J |
| Weight 0 mm stroke | 2.23 kg |
| Weight +10 mm stroke | 0.168 kg |
| Stroke max. | 500 mm |
| Medium | Compressed air |
| Min. medium temperature | -20 °C |
| Max. medium temperature | 80 °C |
| Max. particle size | 50 µm |
| Min. oil content of compressed air | 0 mg/m ³ |
| Max. oil content of compressed air | 5 mg/m ³ |

Material

| | |
|---------------------------|----------------------|
| Piston rod | Stainless Steel |
| Scraper material | Polyurethane |
| Seal material | Polyurethane |
| Material, front cover | Aluminum |
| Cylinder tube | Aluminum |
| End cover | Aluminum |
| Nut for cylinder mounting | Steel, chrome-plated |
| Part No. | R422001140 |

Technical information

ATEX-certified cylinders with identification II 2G Ex h IIC T4 Gb / II 2D Ex h IIIC T135°C Db_X can be generated in the Internet configurator.

The operating temperature range for ATEX-certified cylinders is -20°C ... 60°C.

With cylinders with external thread extension, dimension "A" is increased by the value of the thread extension.

With cylinders with a piston rod extension, dimensions "WH" and "ZB" are increased by the value of the piston rod extension.

The pressure dew point must be at least 15 °C less than ambient and medium temperature and may not exceed 3 °C.

The oil content of compressed air must remain constant during the life cycle.

Use only the approved oils from AVENTICS. Further information can be found in the "Technical information" document (available in <https://www.emerson.com/en-us/support>).

Compact cylinder ISO 21287, Series CCI

series CCI

R422001140

2023-11-23

Dimensions

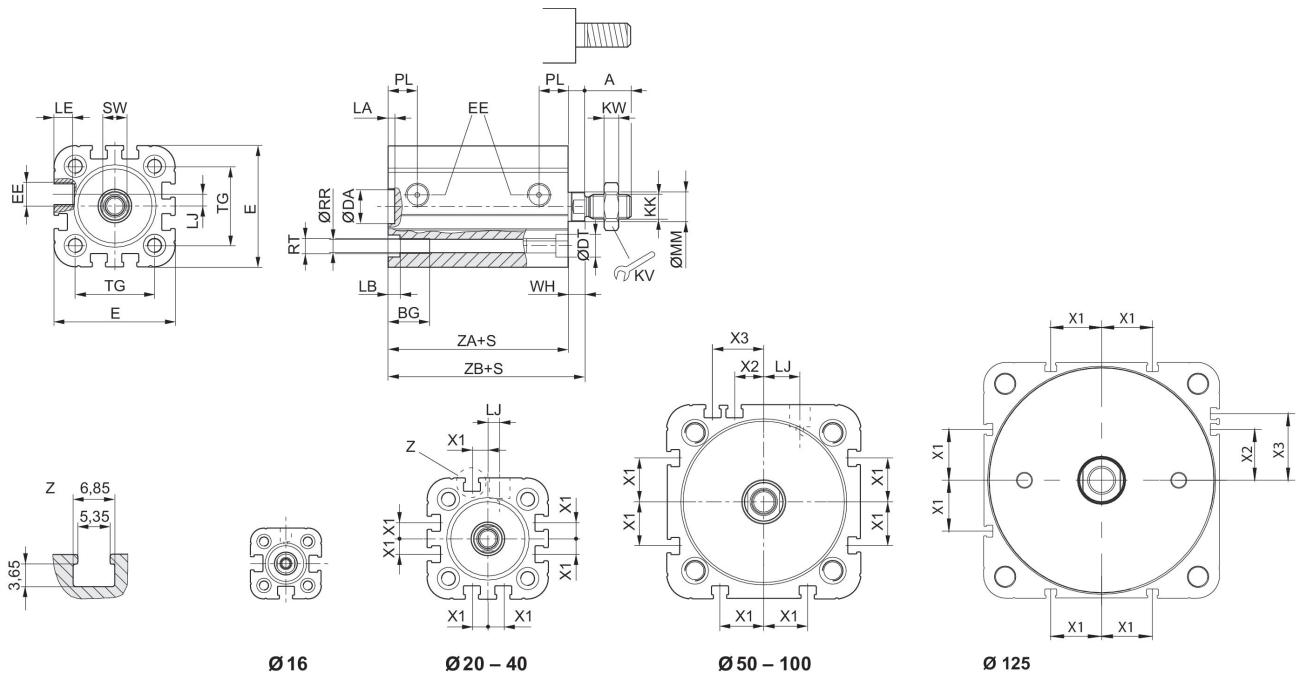

| Piston Ø | A | BG | DA H11 | DT | E | EE | KK | KV | KW |
|----------|----|------|--------|-----|-------|-------|----------|----|----|
| 16 | 12 | 15 | 10 | 6 | 29.3 | M5 | M6 | 10 | 3 |
| 20 | 16 | 15.5 | 12 | 7.5 | 36.3 | M5 | M8 | 13 | 4 |
| 25 | 16 | 15.5 | 12 | 8 | 40.3 | M5 | M8 | 13 | 4 |
| 32 | 19 | 17 | 14 | 8.6 | 50 | G 1/8 | M10x1,25 | 17 | 5 |
| 40 | 19 | 17 | 14 | 9.2 | 58 | G 1/8 | M10x1,25 | 17 | 5 |
| 50 | 22 | 17 | 18 | 11 | 68.3 | G 1/8 | M12x1,25 | 19 | 6 |
| 63 | 22 | 17 | 18 | 11 | 80 | G 1/8 | M12x1,25 | 19 | 6 |
| 80 | 28 | 20 | 23 | 15 | 96 | G 1/8 | M16x1,5 | 24 | 8 |
| 100 | 28 | 20 | 28 | 15 | 116 | G 1/8 | M16x1,5 | 24 | 8 |
| 125 | 40 | 25 | 12 | - | 134.6 | G 1/4 | M20x1.5 | 30 | 10 |

| Piston Ø | LA | LB | LE | LJ | MM f8 | PL | RR | RT 6H | SW |
|----------|-----|-----|-----|------|-------|------|------|-------|----|
| 16 | 2.5 | 3.5 | 4.5 | - | 8 | 8 | 3.3 | M4 | 7 |
| 20 | 2.5 | 4.5 | 4.5 | 4.5 | 10 | 10 | 4.2 | M5 | 8 |
| 25 | 2.5 | 4.5 | 4.5 | 4 | 10 | 10 | 4.2 | M5 | 8 |
| 32 | 2.5 | 5 | 7.5 | 4.85 | 12 | 12 | 5.1 | M6 | 10 |
| 40 | 2.5 | 5 | 7.5 | 9.85 | 12 | 12 | 5.1 | M6 | 10 |
| 50 | 2.5 | 5 | 7.5 | 12 | 16 | 12 | 6.7 | M8 | 13 |
| 63 | 2.5 | 5 | 7.5 | 14.8 | 16 | 12 | 6.7 | M8 | 13 |
| 80 | 3 | 5 | 7.5 | 22 | 20 | 14 | 8.5 | M10 | 16 |
| 100 | 3 | 5 | 7.5 | 27 | 25 | 16.5 | 8.5 | M10 | 21 |
| 125 | 2.6 | - | ??? | 39 | 25 | 20.5 | 11.1 | M12 | 21 |

| Piston Ø | TG | WH | X1 | X2 | X3 | ZA | ZB |
|----------|------|----------|-----|------|------|-----------|-----------|
| 16 | 18 | 4,8 ±0,9 | – | – | – | 34,9 ±0,1 | 39,7 ±0,8 |
| 20 | 22 | 5,6 ±0,9 | 4.2 | – | – | 37,3 ±0,1 | 43,6 ±0,8 |
| 25 | 26 | 5,6 ±0,9 | 4.5 | – | – | 39 ±0,1 | 44,5 ±0,9 |
| 32 | 32.5 | 7,4 ±0,9 | 6.5 | – | – | 44 ±0,1 | 51,4 ±1 |
| 40 | 38 | 7,4 ±0,9 | 11 | – | – | 45 ±0,1 | 52,4 ±1 |
| 50 | 46.5 | 8,4 ±0,9 | 13 | 4 | 13 | 45,5 ±0,1 | 53,6 ±1 |
| 63 | 56.5 | 8,5 ±0,9 | 18 | 12 | 21 | 49 ±0,1 | 57,4 ±1 |
| 80 | 72 | 9,8 ±1 | 18 | 16.5 | 25.5 | 54,7 ±0,1 | 64,4 ±1 |
| 100 | 89 | 9,8 ±1 | 20 | 20 | 29 | 67 ±0,1 | 76,7 ±1 |
| 125 | 110 | 11 | 29 | 29 | 38 | 81 | 92 ±1 |

Maximum admissible lateral force dynamic

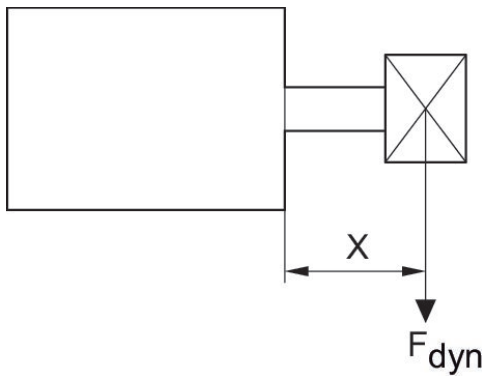

F_{dyn} = dynamic lateral force
 X = distance between force application point and cylinder cover
 S = stroke

Maximum admissible lateral force dynamic



F_{dyn} = dynamic lateral force
 X = distance between force application point and cylinder cover
 S = stroke

Maximum admissible lateral force static



F_{stat} = static lateral force
 X = distance between force application point and cylinder cover

Maximum admissible lateral force static



F_{stat} = static lateral force
 X = distance between force application point and cylinder cover
 S = stroke

Overview drawing



NOTE: This overview drawing is only for orientation to indicate where the various accessory parts can be fastened to the cylinder. The illustration has been simplified for this purpose. It is thus not possible to derive the dimensions from this overview.