

Compact cylinder, Series CCI-SC

R452000796

General series information
AVENTICS Serie CCI-SC Stopper Compact
Cylinders

- Pneumatic cylinders with reinforced piston rod, featuring high resistance to shocks and radial loads. Typically used in conveyor belts and other special machinery, to allow stopping loads smoothly and safely, up to 90Kg weight. Mounting holes dimensions are compatible with ISO 21287.



Technical data

Industry	Industrial
Standards	Based on ISO 21287
Piston Ø	50 mm
Stroke	25 mm
Ports	1/8 NPT
Functional principle	double-acting with spring return, extended without pressure
Cushioning	Elastic cushioning
Magnetic piston	Piston with magnet
Cylinder special features	Axle pivot version non-rotating
Pressure for determining piston forces	6,3 bar
Retracting piston force	730 N
Extracting piston force	1237 N
Min. ambient temperature	-20 °C
Max. ambient temperature	80 °C

Working pressure min.	2 bar
Working pressure max	10 bar
Spring force max.	82 N
Max. permissible radial bearing load	6280 N
Max. permissible radial bearing load F during switching operation	1500 N
Medium	Compressed air
Min. medium temperature	-20 °C
Max. medium temperature	80 °C
Max. particle size	50 µm
Oil content of compressed air max.	5 mg/m ³

Material

Piston rod	Stainless Steel
Material, front cover	Aluminum
Cylinder tube	Aluminum
End cover	Aluminum
Part No.	R452000796

Technical information

The pressure dew point must be at least 15 °C less than ambient and medium temperature and may not exceed 3 °C.

The oil content of compressed air must remain constant during the life cycle.

Use only the approved oils from AVENTICS. Further information can be found in the "Technical information" document (available in <https://www.emerson.com/en-us/support>).

Dimensions in mm

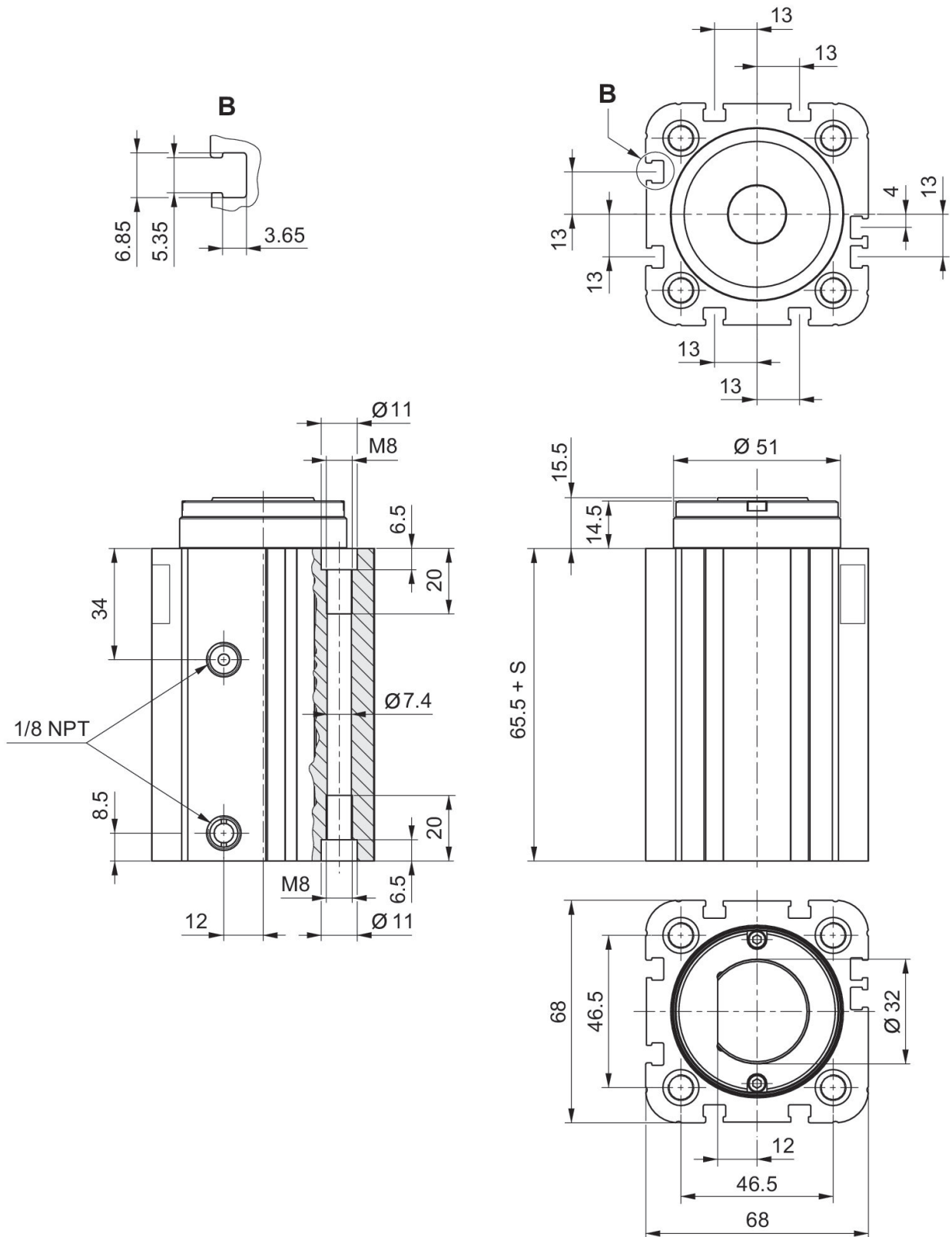

Maximum permissible moving mass
depending on the impact speed
Ø 50 mm
Axle pivot version

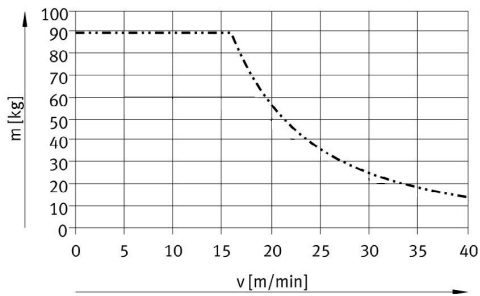

Max. permissible radial bearing load F
during switching operation
Ø 50 mm
Axle pivot version

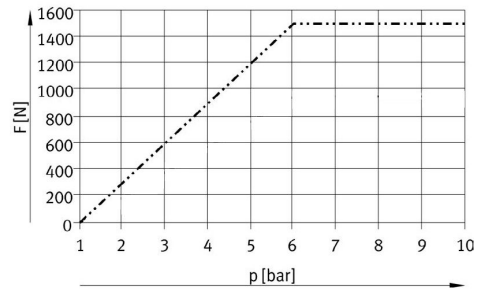

Accessories overview

