

ISO 15552, series CCL-IS

R481609647

General series information
AVENTICS Series CCL-IS Standard cylinders
(ISO 15552)

- The CCL-IS (Cylinder Clean Line - ISO Standard) series cylinders complement the PRA series in the area of hygienic design and meet all requirements for use in the food sector. A special feature is the option to configure the air connections for supply and exhaust on just the base, which increases flexibility when designing the system's tubing concept..
- Optional: through piston rod, dry-run scraper, modular scraper system, lube unit, heat-resistant, especially high corrosion resistance, ATEX



Technical data

| | |
|----------------------------|--|
| Industry | Industrial |
| Standards | ISO 15552 |
| Type | Dry-run scraper for increased service life in grease-free operation |
| Piston Ø | 40 mm |
| Stroke | 80 mm |
| Ports | G 1/4 |
| Functional principle | Double-acting |
| Cushioning | Pneumatic adjustable cushioning |
| Magnetic piston | Piston with magnet |
| Environmental requirements | Industry standard suitable for use in food processing High corrosion |
| Piston rod | single |
| Cylinder special features | Dry-Run Scraper |

| | |
|--|---------------------|
| Scraper | Dry-Run Scraper |
| Pressure for determining piston forces | 6,3 bar |
| Retracting piston force | 665 N |
| Extracting piston force | 792 N |
| Min. ambient temperature | -20 °C |
| Max. ambient temperature | 80 °C |
| Working pressure min. | 1.5 bar |
| Working pressure max | 10 bar |
| Piston rod thread | M12x1,25 |
| Cushioning length | 19 mm |
| Cushioning energy | 9 J |
| Weight 0 mm stroke | 0.92 kg |
| Weight +10 mm stroke | 0.049 kg |
| Stroke max. | 1900 mm |
| Medium | Compressed air |
| Min. medium temperature | -20 °C |
| Max. medium temperature | 80 °C |
| Max. particle size | 50 µm |
| Oil content of compressed air min. | 0 mg/m ³ |
| Oil content of compressed air max. | 5 mg/m ³ |

Material

| | |
|-----------------------|--|
| Piston rod | Stainless Steel |
| Scraper material | Ultra-high-molecular-weight polyethylene (UHMW-PE) |
| Material tie-rod | Stainless Steel |
| Material, front cover | Aluminum |
| Cylinder tube | Aluminum |
| End cover | Aluminum |
| Part No. | R481609647 |

Technical information

Further options can be generated in the Internet configurator.

The pressure dew point must be at least 15 °C less than ambient and medium temperature and may not exceed 3 °C.

Dimensions

Ø 32 - 63

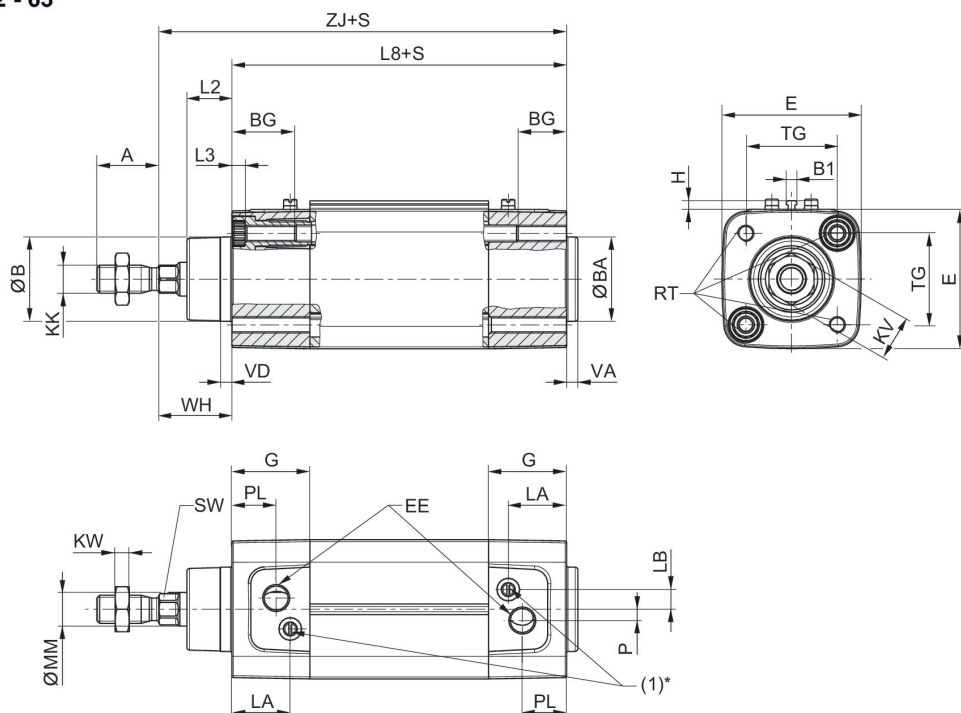

Ø80 - 125

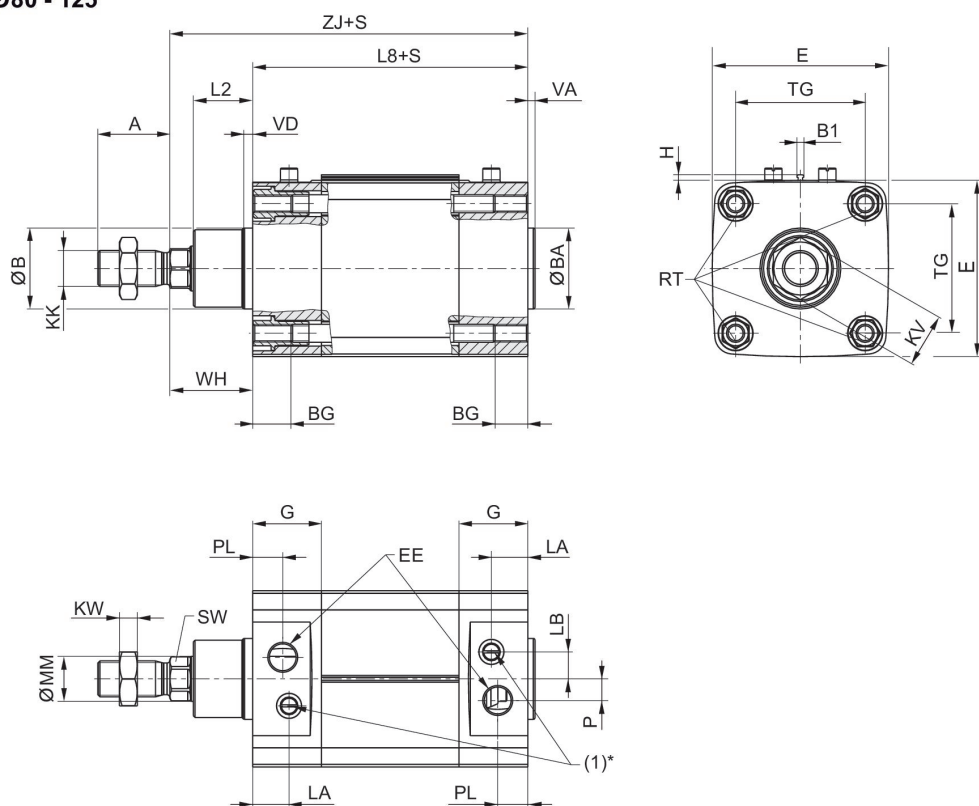

S=stroke

* The flow control screw (1) only has a function in cylinders with adjustable cushioning.

Ø80 - 125

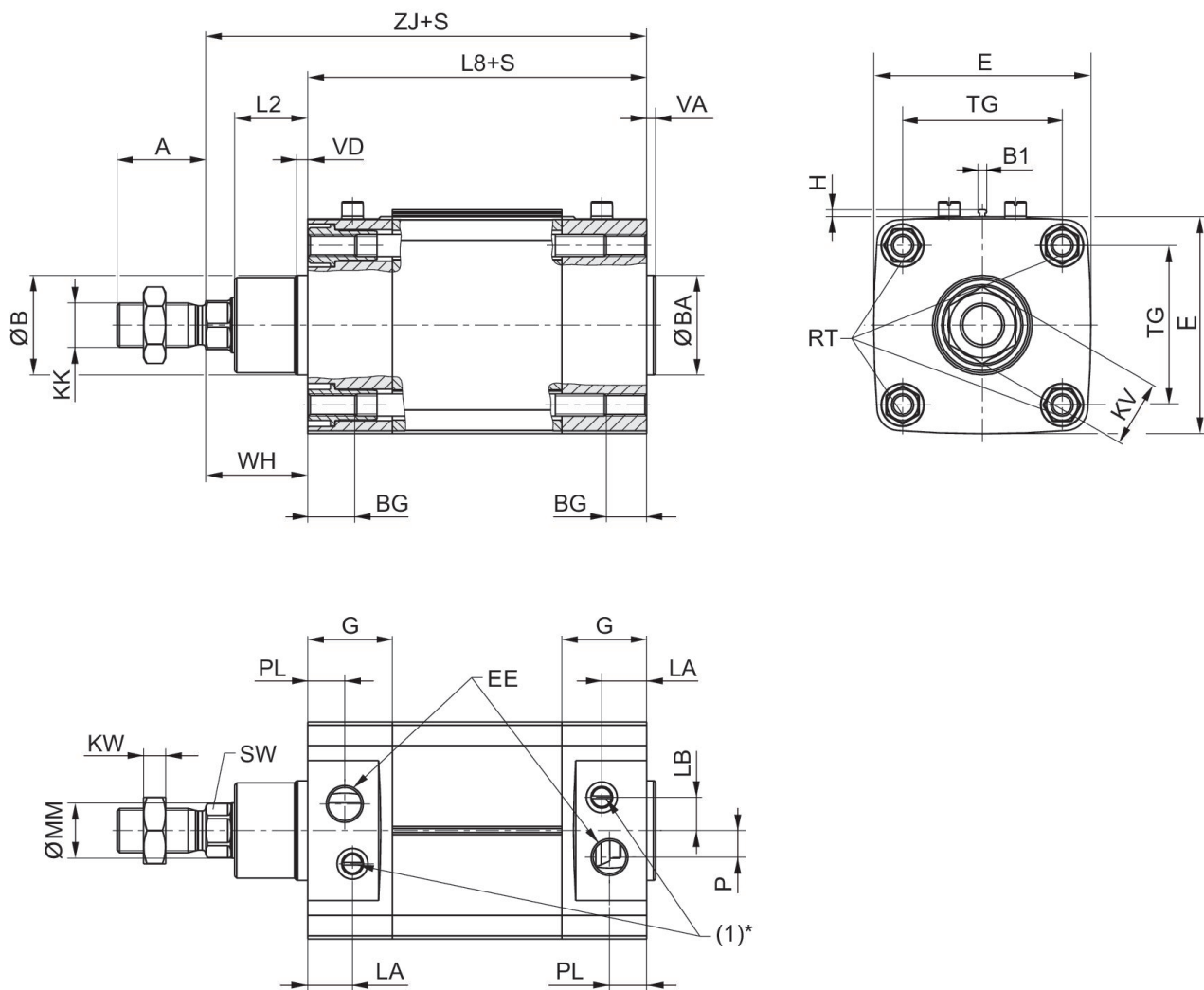

S = stroke

* The flow control screw (1) only has a function in cylinders with adjustable cushioning.

| Piston Ø | A | ØB / ØBA d11 | B1 | BG mm | E | EE | G | H | KK |
|----------|----|--------------|-----|-------|-------|------|-------|-----|----------|
| 32 | 22 | 30 | 3.8 | 16 | 49.5 | G1/8 | 27.75 | 3.1 | M10x1,25 |
| 40 | 24 | 35 | 3.8 | 16 | 57.5 | G1/4 | 33.25 | 3.1 | M12x1,25 |
| 50 | 32 | 40 | 3.8 | 16 | 69.5 | G1/4 | 31 | 3.1 | M16x1,5 |
| 63 | 32 | 45 | 3.8 | 16 | 79.5 | G3/8 | 38,25 | 3.1 | M16x1,5 |
| 80 | 40 | 45 | 3.8 | 17 | 98 | G3/8 | 38,25 | 3.1 | M20x1,5 |
| 100 | 40 | 55 | 3.8 | 17 | 115,5 | G1/2 | 42,25 | 3.1 | M20x1,5 |
| 125 | 54 | 60 | 3.8 | 20 | 145 | G1/2 | 54 | 3.1 | M27x2 |

| Piston Ø | KV | KW | L2 | L3 max. | L8 | LA | LB | MM f8 | P |
|----------|----|----|----|---------|---------|-------|----|-------|---|
| 32 | 16 | 5 | 16 | 5 | 94 ±0,4 | 20.75 | 7 | 12 | 4 |

| Piston Ø | KV | KW | L2 | L3 max. | L8 | LA | LB | MM f8 | P |
|----------|----|------|-------|---------|----------|-------|----|-------|------|
| 40 | 18 | 6 | 18.25 | 5 | 105 ±0,7 | 22,75 | 8 | 16 | 5 |
| 50 | 24 | 8 | 25 | 5 | 106 ±0,7 | 20 | 12 | 20 | 7,7 |
| 63 | 24 | 8 | 25 | 5 | 121 ±0,8 | 27,25 | 11 | 20 | 11 |
| 80 | 30 | 10 | 33 | - | 128 ±0,8 | 20,25 | 15 | 25 | 12 |
| 100 | 30 | 10 | 36 | - | 138 ±1 | 24,25 | 14 | 25 | 17 |
| 125 | 41 | 13,5 | 45 | - | 160 ±1 | 25,5 | 4 | 32 | 27,5 |

| Piston Ø | PL | RT | SW | TG | VA | VD | WH | ZJ |
|----------|-------|-----|----|-----------|----|----|---------|-----|
| 32 | 15.75 | M6 | 10 | 32,5 ±0,5 | 4 | 4 | 26 ±1,4 | 120 |
| 40 | 16.75 | M6 | 13 | 38 ±0,5 | 4 | 5 | 30 ±1,4 | 135 |
| 50 | 16 | M8 | 17 | 46,5 ±0,6 | 4 | 5 | 37 ±1,4 | 143 |
| 63 | 19,25 | M8 | 17 | 56,5 ±0,7 | 4 | 5 | 37 ±1,8 | 158 |
| 80 | 16,75 | M10 | 22 | 72 ±0,7 | 4 | 5 | 46 ±1,8 | 174 |
| 100 | 19,25 | M10 | 22 | 89 ±0,7 | 4 | 5 | 51 ±1,8 | 189 |
| 125 | 20 | M12 | 27 | 110 ±1,1 | 6 | 6 | 65 ±2,2 | 225 |

Cushioning diagram

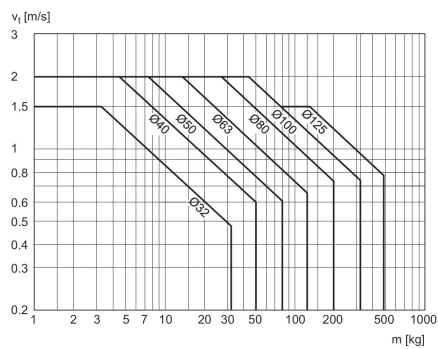

V = velocity [m/s]
m = mass

Overview drawing

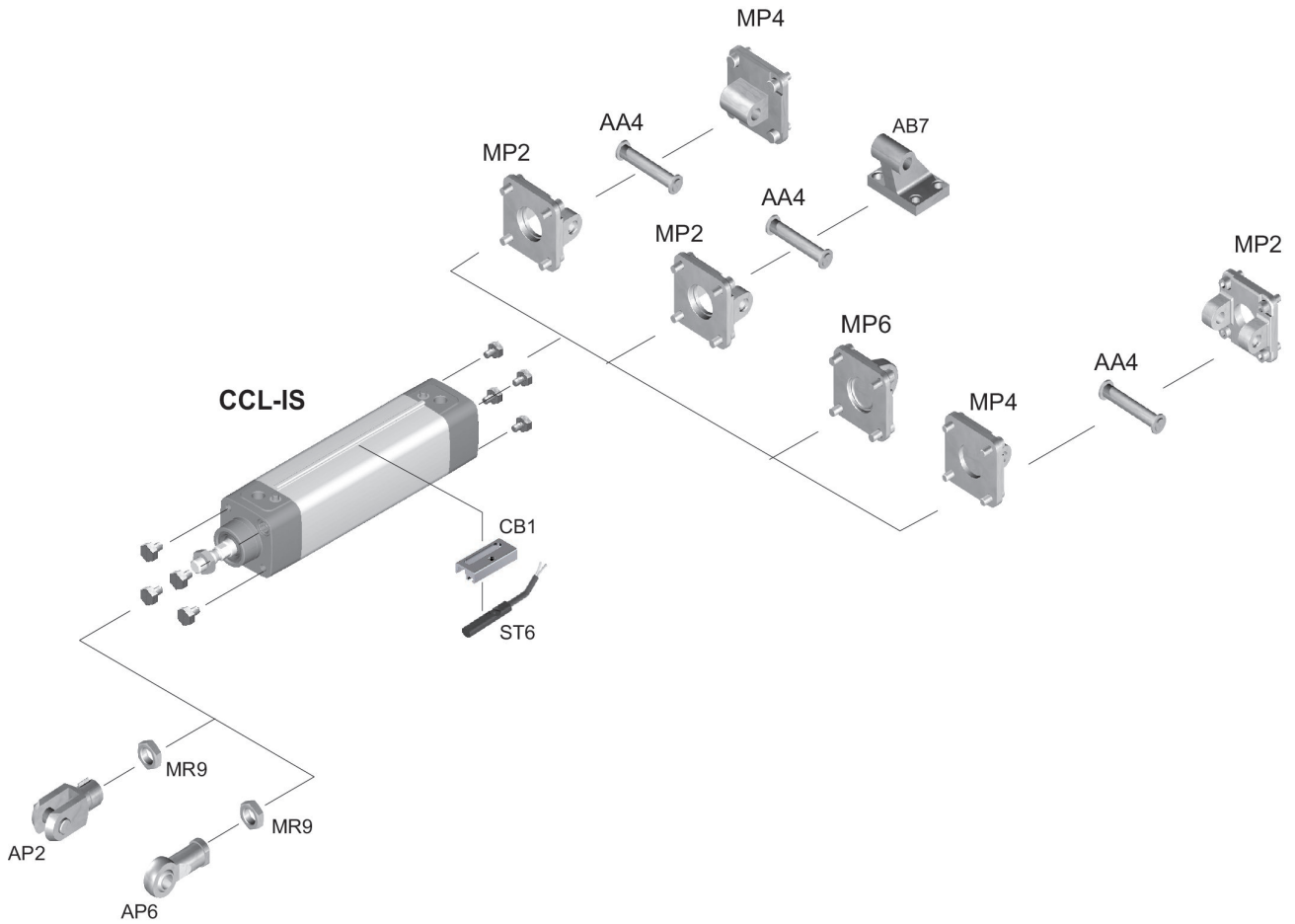

NOTE: This overview drawing is only for orientation to indicate where the various accessory parts can be fastened to the cylinder. The illustration has been simplified for this purpose. It is thus not possible to derive the dimensions from this overview.