

ISO 21287, Series CCL-IC

R480668735

General series information
AVENTICS Series CCL-IC Standard cylinders
(ISO 21287)

- The AVENTICS Series CCL-IC (ISO 21287) cylinders with their compact and clean design can be used in a wide range of applications. Their smooth surface together with their materials, such as anodized aluminium, stainless steel, and NSF-H1 lubricants, make the cylinder ideal for the demanding requirements in the food and beverage industry.



Technical data

| | |
|--|---|
| Industry | Industrial |
| Standards | ISO 21287 |
| Piston Ø | 40 mm |
| Stroke | 150 mm |
| Ports | G 1/8 |
| Functional principle | Double-acting |
| Cushioning | Elastic cushioning |
| Magnetic piston | Piston with magnet |
| Environmental requirements | Industry standard suitable for use in food processing ATEX optional High corrosion |
| Piston rod | single |
| Scraper | Standard Industry Scraper |
| Pressure for determining piston forces | 6,3 bar |

| | |
|------------------------------------|---------------------|
| Retracting piston force | 720 N |
| Extracting piston force | 792 N |
| Min. ambient temperature | -20 °C |
| Max. ambient temperature | 80 °C |
| Working pressure min. | 1 bar |
| Working pressure max | 10 bar |
| Piston rod thread | M10x1,25 |
| Impact energy | 0.7 J |
| Weight 0 mm stroke | 0.401 kg |
| Weight +10 mm stroke | 0.04 kg |
| Stroke max. | 300 mm |
| Medium | Compressed air |
| Min. medium temperature | -20 °C |
| Max. medium temperature | 80 °C |
| Max. particle size | 50 µm |
| Oil content of compressed air min. | 0 mg/m ³ |
| Oil content of compressed air max. | 5 mg/m ³ |

Material

| | |
|-----------------------|-----------------|
| Piston rod | Stainless Steel |
| Scraper material | Polyurethane |
| Material, front cover | Aluminum |
| Cylinder tube | Aluminum |
| End cover | Aluminum |
| Part No. | R480668735 |

Technical information

The material for heat-resistant scraper and seal variants (ambient temperature: -10 °C ... 120 °C) is fluorocarbon.

Further options can be generated in the Internet configurator.

LW*/SW* Hexagonal key required

The pressure dew point must be at least 15 °C less than ambient and medium temperature and may not exceed 3 °C.

The oil content of compressed air must remain constant during the life cycle.

ATEX-certified cylinders with identification II 2G Ex h IIC T4 Gb / II 2D Ex h IIC T135°C Db_X can be generated in the Internet configurator.

Dimensions

Ø16 - 63



Ø80 - 100

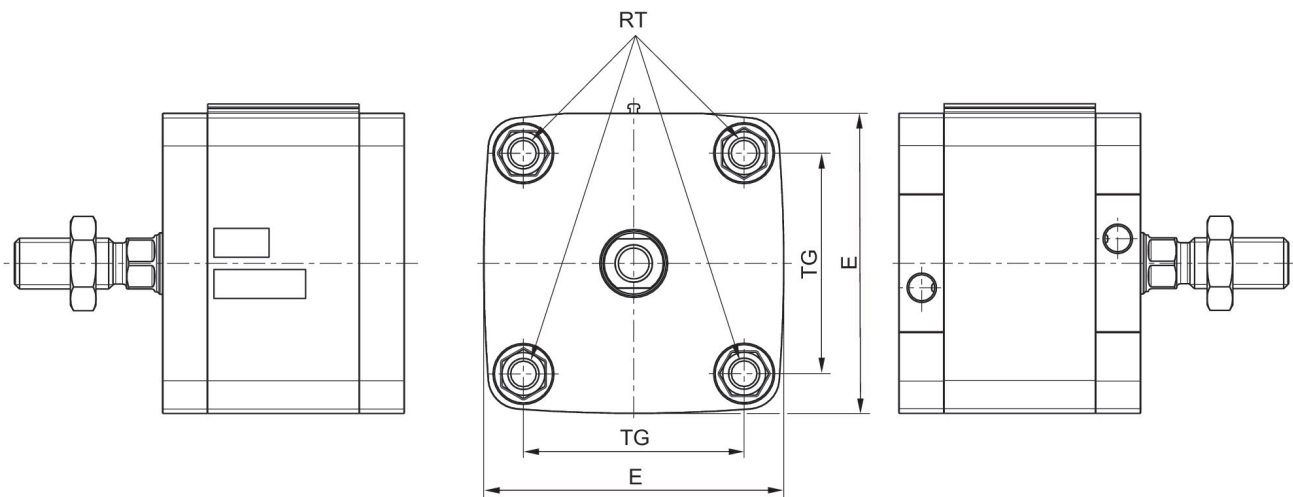

S = stroke

| Piston Ø | A | B1 | BG min. | E | EE | H | KK | KV | KW |
|----------|----|-----|---------|----------------------|------|-----|----------|----|-----|
| 16 | 12 | 3.8 | 15 | 29 | M5 | 3.1 | M6 | 10 | 3.2 |
| 20 | 16 | 3.8 | 15 | 36.5 | M5 | 3.1 | M8 | 13 | 4 |
| 25 | 16 | 3.8 | 15 | 40.5 | M5 | 3.1 | M8 | 13 | 4 |
| 32 | 19 | 3.8 | 16 | 49.5 | G1/8 | 3.1 | M10x1.25 | 17 | 5 |
| 40 | 19 | 3.8 | 16 | 57.5 | G1/8 | 3.1 | M10x1.25 | 17 | 5 |
| 50 | 22 | 3.8 | 16 | 69.5 | G1/8 | 3.1 | M12x1.25 | 18 | 6 |
| 63 | 22 | 3.8 | 16 | 79.5 | G1/8 | 3.1 | M12x1.25 | 18 | 6 |
| 80 | 28 | 3.8 | 17 | 98 / ISO 21287:96 | G1/8 | 3.1 | M16x1.5 | 24 | 8 |
| 100 | 28 | 3.8 | 17 | 115.5 | G1/8 | 3.1 | M16x1.5 | 24 | 8 |

| Piston Ø | LA | LA1 | LW | LW* | MM f8 | PL | RR min. | RT | SW |
|----------|-----|-----|-----|------|-------|-----|---------|-----|----|
| 16 | 3.5 | 3.5 | 3.2 | 3.2 | 8 | 5 | 3.2 | M4 | 7 |
| 20 | 4.8 | 4.6 | 3.7 | 3.7 | 10 | 5 | 4.1 | M5 | 8 |
| 25 | 4.8 | 4.6 | 3.7 | 3.7 | 10 | 5 | 4.1 | M5 | 8 |
| 32 | 4.8 | 4.8 | 5 | 5* | 12 | 7.5 | 5.1 | M6 | 10 |
| 40 | 4.8 | 4.8 | 5 | 5* | 12 | 7.5 | 5.1 | M6 | 10 |
| 50 | 4.8 | 4.8 | 5.7 | 4,8* | 16 | 7.5 | 6.4 | M8 | 13 |
| 63 | 4.8 | 4.8 | 5.7 | 4,8* | 16 | 7.5 | 6.4 | M8 | 13 |
| 80 | 0 | 0 | 7 | 6,4* | 20 | 7.5 | 8.4 | M10 | 16 |
| 100 | 0 | 0 | 7.5 | 6,4* | 25 | 7.5 | 8.4 | M10 | 21 |

| Piston Ø | SW* | TG | WH | ZA +S | ZB+S |
|----------|-----|-----------|----------|-------|------|
| 16 | 7 | 18 ±0,4 | 4,8 ±1,4 | 36 | 40.8 |
| 20 | 8 | 22 ±0,4 | 6 ±1,4 | 37 | 43 |
| 25 | 8 | 26 ±0,4 | 6 ±1,4 | 39 | 45 |
| 32 | 10* | 32,5 ±0,5 | 7 ±1,6 | 44 | 51 |
| 40 | 10* | 38 ±0,5 | 7 ±1,6 | 45 | 52 |
| 50 | 13* | 46,5 ±0,6 | 8 ±1,6 | 45.5 | 53.5 |
| 63 | 13* | 56,5 ±0,7 | 8 ±1,6 | 49 | 57 |
| 80 | 16* | 72 ±0,7 | 10 ±2 | 54 | 64 |
| 100 | 21* | 89 ±0,7 | 10 ±2 | 67 | 77 |

Dimensions

Ø80 - 100



Overview drawing



NOTE: This overview drawing is only for orientation to indicate where the various accessory parts can be fastened to the cylinder. The illustration has been simplified for this purpose. It is thus not possible to derive the dimensions from this overview.