

ISO 21287, Series CCL-IC

R480668934

AVENTICS
Series CCL-
IC Standard
cylinders
(ISO 21287)

AVENTICS Series CCL-IC Standard cylinders (ISO 21287)

The AVENTICS Series CCL-IC (ISO 21287) cylinders with their compact and clean design can be used in a wide range of applications. Their smooth surface together with their materials, such as anodized aluminium, stainless steel, and NSF-H1 lubricants, make the cylinder ideal for the demanding requirements in the food and beverage industry.



Technical data

Industry	Industrial
Standards	ISO 21287
Piston Ø	20 mm
Stroke	20 mm
Ports	M5
Functional principle	Single-acting, retracted without pressure
Cushioning	Elastic cushioning
Magnetic piston	Piston with magnet
Environmental requirements	Industry standard suitable for use in food processing High corrosion
Piston rod thread - type	Internal thread
Piston rod thread	M6
Piston rod	single
Scraper	Standard Industry Scraper
Pressure for determining piston forces	6,3 bar
Retracting piston force	13 N
Extracting piston force	185 N
Min. ambient temperature	-20 °C
Max. ambient temperature	80 °C

ISO 21287, Series CCL-IC

R480668934

AVENTICS
Series CCL-
IC Standard
cylinders
(ISO 21287)

2023-12-04

Min. working pressure	1 bar
Max. working pressure	10 bar
Max. spring force	13 N
Impact energy	0.15 J
Weight 0 mm stroke	0.12 kg
Weight +10 mm stroke	0.019 kg
Stroke max.	25 mm
Medium	Compressed air
Min. medium temperature	-20 °C
Max. medium temperature	80 °C
Max. particle size	50 µm
Min. oil content of compressed air	0 mg/m ³
Max. oil content of compressed air	5 mg/m ³

Material

Piston rod	Stainless Steel
Scraper material	Polyurethane
Material, front cover	Aluminum
Cylinder tube	Aluminum
End cover	Aluminum
Part No.	R480668934

Technical information

Further options can be generated in the Internet configurator.

The pressure dew point must be at least 15 °C less than ambient and medium temperature and may not exceed 3 °C.

ISO 21287, Series CCL-IC

R480668934

AVENTICS
Series CCL-
IC Standard
cylinders
(ISO 21287)

Dimensions

Ø16 - 63

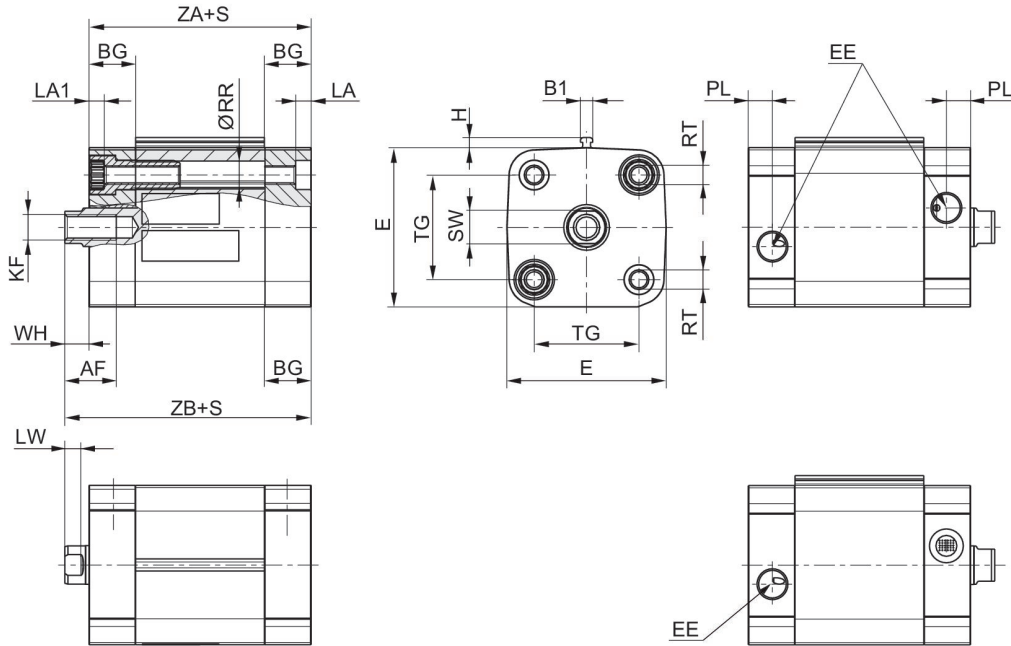

Ø80 - 100

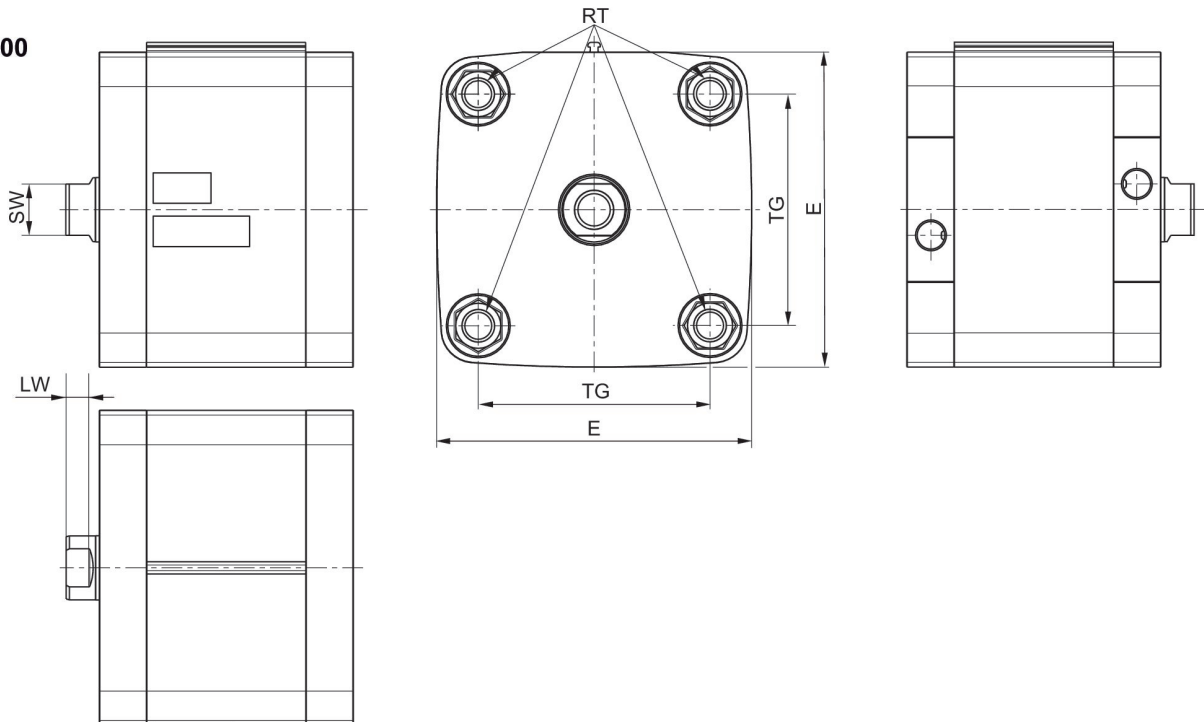

S = stroke

Piston Ø	AF	B1	BG min.	E	EE	H	Kf	LA	LA1
16	10	3.8	15	29	M5	3.1	M4	3.5	3.5
20	10	3.8	15	36.5	M5	3.1	M6	4.8	4.6

ISO 21287, Series CCL-IC

R480668934

AVENTICS
Series CCL-
IC Standard
cylinders

Piston Ø	AF	B1	BG min.	E	EE	H	KF	LA	LA1
25	10	3.8	15	40.5	M5	3.1	M6	4.8	4.6
32	12	3.8	16	49.5	G1/8	3.1	M8	4.8	4.8
40	12	3.8	16	57.5	G1/8	3.1	M8	4.8	4.8
50	16	3.8	16	69.5	G1/8	3.1	M10	4.8	4.8
63	16	3.8	16	79.5	G1/8	3.1	M10	4.8	4.8

Piston Ø	LW	PL	RR min.	RT	SW	TG	WH	ZA+S	ZB+S
16	3.2	5	3.2	M4	7	18 ±0,5	4.8 ±1,4	36	40.8
20	3.7	5	4.1	M5	8	22 ±0,4	6 ±1,4	37	43
25	3.7	5	4.1	M5	8	26 ±0,4	6 ±1,4	39	45
32	5	7.5	5.1	M6	10	32.5 ±0,5	7 ±1,6	44	51
40	5	7.5	5.1	M6	10	38 ±0,5	7 ±1,6	45	52
50	5.7	7.5	6.4	M8	13	46.5 ±0,5	8 ±1,6	45.5	53.5
63	5.7	7.5	6.4	M8	13	56.5 ±0,5	8 ±1,6	49	57

Extracting piston force

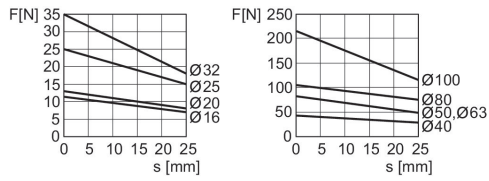

F = spring return force, s = return stroke

ISO 21287, Series CCL-IC

R480668934

AVENTICS
Series CCL-
IC Standard
cylinders
(ISO 21287)

Overview drawing

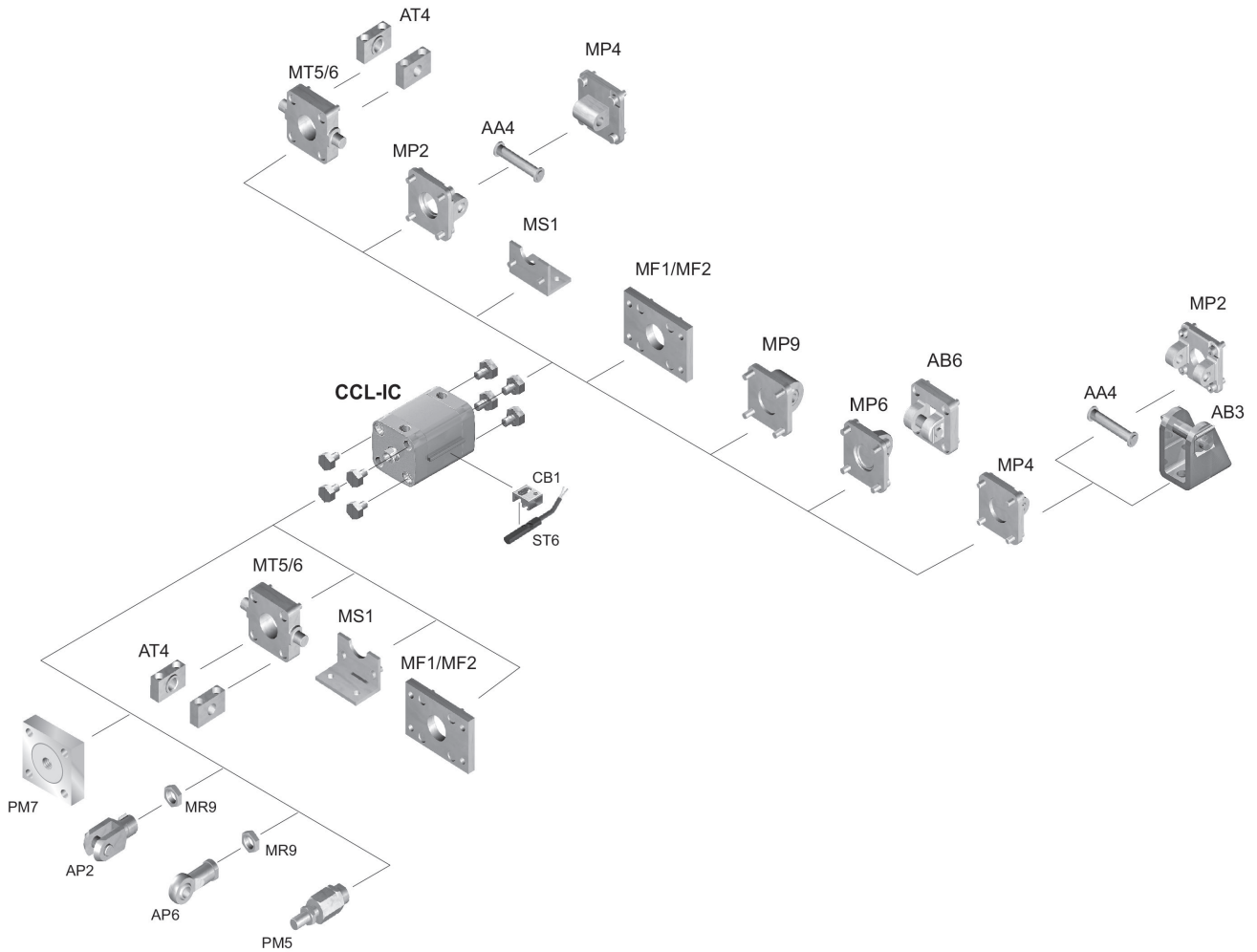

NOTE: This overview drawing is only for orientation to indicate where the various accessory parts can be fastened to the cylinder. The illustration has been simplified for this purpose. It is thus not possible to derive the dimensions from this overview.