

5763510210

AVENTICS Series CD01-PA Standardized valve systems (ISO 15407-1)

The AVENTICS Series CD01-PA is the flexible valve system according to ISO 15407-1. The Series offers pneumatic or electrical control, vacuum or pressure of up to 16 bar, dual-pressure application, pressure-zones, ATEX certification, and various accessories allow for a wide range of modularity.

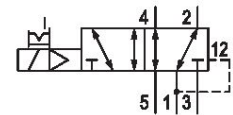
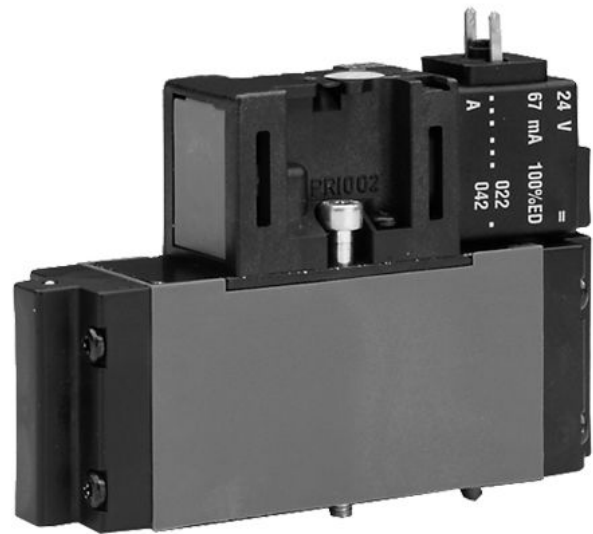

Technical data

Industry	Industrial
Activation	Electrically
Nominal flow Qn	1010 l/min
Compressed air connection output	base plate DIN ISO 15407-1
Min. working pressure	3 bar
Max. working pressure	10 bar
Operational voltage	12 V DC
Operational voltage DC	12 V
Voltage tolerance DC	-10% / +10%
Manual override	with detent
Electrical connection type	Plug
Electrical connection size	EN 175301-803, form C
Actuating control	Single Solenoid
Sealing principle	Soft seal
Pilot	Internal
Certificates	Free of substances that impair surface wetting in the coating process
Standards	ISO 15407-1
Pilot valve width	26 mm
Valve type	Spool valve, positive overlapping

5/2-directional valve, Series CD01-PA

2023-12-13

5763510210

Connection type	Plate connection
Return	with air spring return
Compressed air connection input	base plate DIN ISO 15407-1
Compressed air connection, exhaust	base plate DIN ISO 15407-1
Compressed air connection pilot input	base plate DIN ISO 15407-1
Compressed air connection pilot exhaust	base plate DIN ISO 15407-1
Power consumption DC	1.6 W
Frame size	26 mm
Min. control pressure	3 bar
Max. control pressure	10 bar
Min. ambient temperature	-15 °C
Max. ambient temperature	50 °C
Min. medium temperature	-15 °C
Max. medium temperature	50 °C
Medium	Compressed air
Max. particle size	50 µm
Min. oil content of compressed air	0 mg/m ³
Max. oil content of compressed air	5 mg/m ³
Connector standard	EN 175301-803, form C
Standard compressed air connection	according to ISO 15407-1
Nominal flow Qn 1 to 2	1010 l/min
Nominal flow Qn 2 to 3	1010 l/min
Protection class with connection	IP65
Duty cycle	100 %
Typ. switch-on time	29 ms
Typ. switch-off time	42 ms
Mounting screws	M4 with hexagon socket
Mounting screw tightening torque	2.5 Nm
Weight	0.21 kg
Housing material	Polyamide Polyoxymethylene
Seal material	Acrylonitrile butadiene rubber
Part No.	5763510210

Technical information

Versions with voltage of less than 50 V DC do not have a protective ground.

The min. control pressure must be adhered to, since otherwise faulty switching and valve failure may result!

The pressure dew point must be at least 15 °C less than ambient and medium temperature and may not exceed 3 °C.

The oil content of compressed air must remain constant during the life cycle.

Use only the approved oils from AVENTICS. Further information can be found in the "Technical information" document (available in <https://www.emerson.com/en-us/support>).

5/2-directional valve, Series CD01-PA

2023-12-13

5763510210

Dimensions

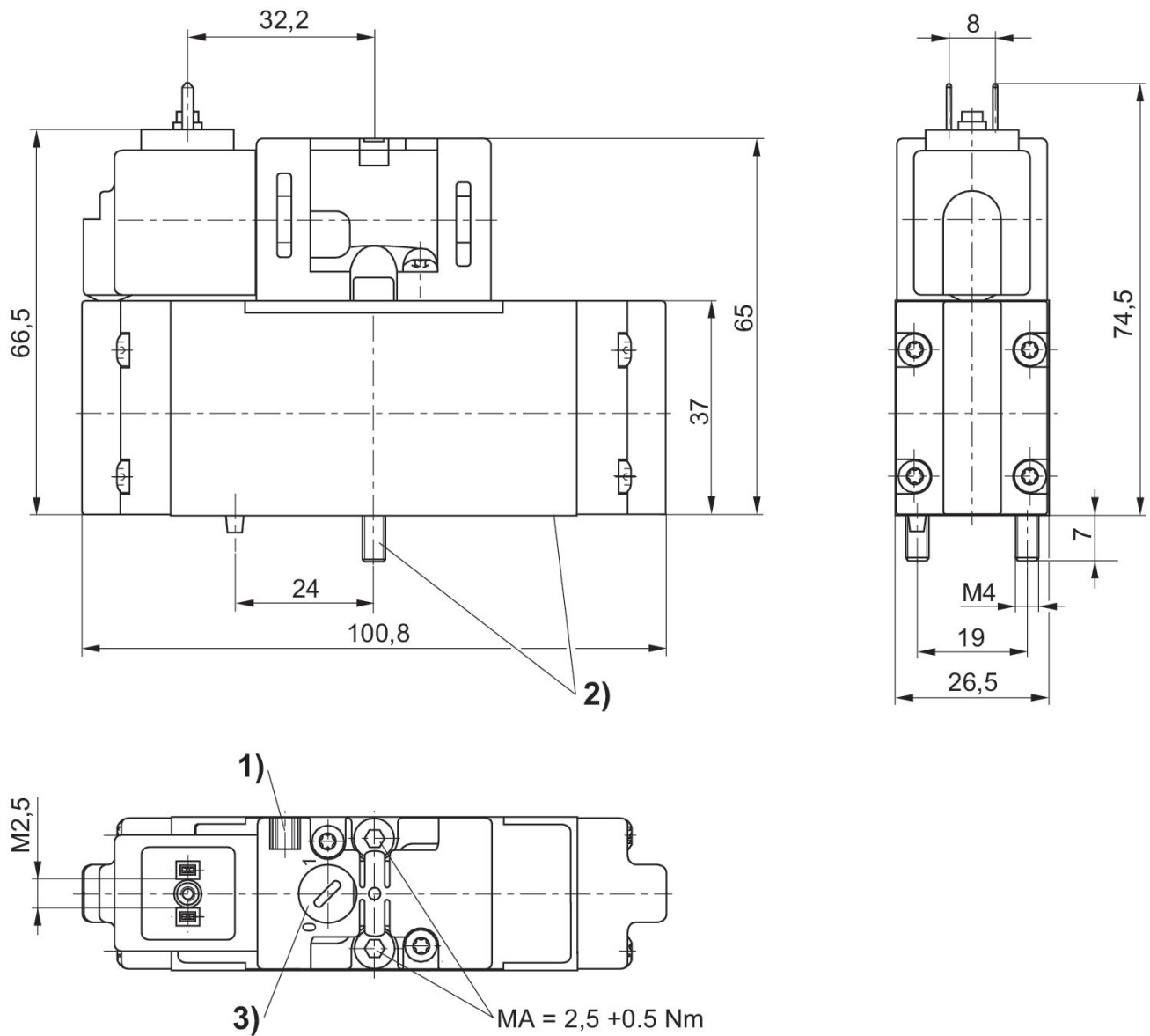

1) mounting space for name plate 2) screws and seals captive 3) manual override

5763510210

Minimum control pressure for externally piloted valves (depending on the working pressure)

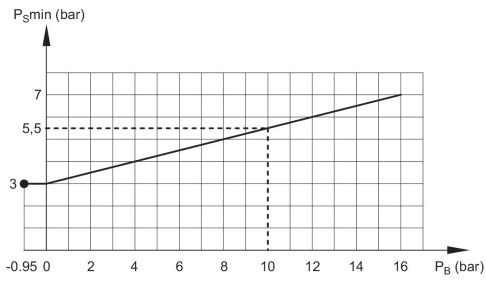

P_B = Working pressure
 P_S = control pressure