

5/3-directional valve, Series CD07

R432016592

General series information
AVENTICS Series CD07 Directional valves

- The AVENTICS Series CD consists of various spool valves with an extremely durable die-cast zinc housing. Its electrical, pneumatic, or mechanical actuating controls (roller, lever, pedal, or plunger) make the Series CD ideal for applications in harsh environments.

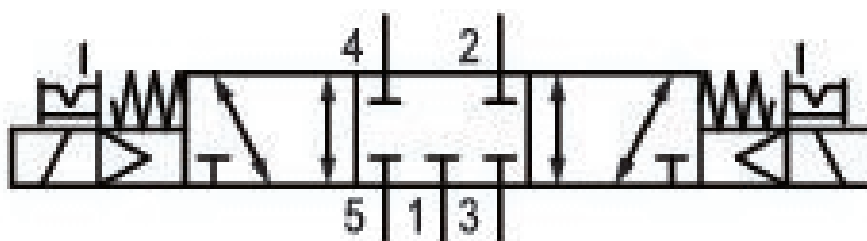

Technical data

Industry	Industrial
Activation	Electrically
Frame size	CD07 - inch
Valve type	Spool valve, positive overlapping
Switching principle	5/3, closed center
Valve function	Closed Center
Actuating control	Double Solenoid
Sealing principle	soft seal
Connection type	Pipe connection
Manual override	with detent
Compressed air connection	1/4 NPT

Standard compressed air connection	according to ISO 228-1
Compressed air connection input	1/4 NPT
Compressed air connection output	1/4 NPT
Compressed air connection, exhaust	1/4 NPT
Pilot control exhaust	with directional pilot air exhaust
Compressed air connection pilot exhaust	M5
Nominal flow Qn	900 l/min
Nominal flow Qn 1 to 2	900 l/min
Nominal flow Qn 2 to 3	900 l/min
Working pressure min.	3 bar
Working pressure max	10 bar
Control pressure min.	3 bar
Control pressure max.	10 bar
Electrical connection type	Plug
Electrical connection size	EN 175301-803, form A
Electrical connection number of poles	3-pin
Connector standard	EN 175301-803:2006
Protection class with connection	IP65
Reverse polarity protection	Protected against polarity reversal
Operational voltage	24 V DC
DC operating voltage	24 V
Voltage tolerance DC	-10% / +10%
Pilot	Internal
Coil width	30 mm
Compatibility index	13 14
Power consumption DC	2.7 W
Duty cycle	100 %
Typ. switch-on time	25 ms
Typ. switch-off time	55 ms
Min. ambient temperature	-15 °C
Max. ambient temperature	50 °C
Min. medium temperature	-15 °C
Max. medium temperature	50 °C
Medium	Compressed air

Oil content of compressed air min.	0 mg/m ³
Oil content of compressed air max.	1 mg/m ³
Max. particle size	50 µm
Mounting on manifold strip	P-strip PRS strip
Weight	0.72 kg

Material

Housing material	Die cast zinc Polyamide fiber-glass reinforced
Seal material	Acrylonitrile butadiene rubber
Part No.	R432016592

Technical information

ATEX optional: ATEX version can be produced by combining the basic valve without coil with an ATEX coil. ATEX ID: see ATEX coils catalog page.

The min. control pressure must be adhered to, since otherwise faulty switching and valve failure may result!

The pressure dew point must be at least 15 °C less than ambient and medium temperature and may not exceed 3 °C.

The oil content of compressed air must remain constant during the life cycle.

Use only the approved oils from AVENTICS. Further information can be found in the "Technical information" document (available in <https://www.emerson.com/en-us/support>).

Dimensions in inches

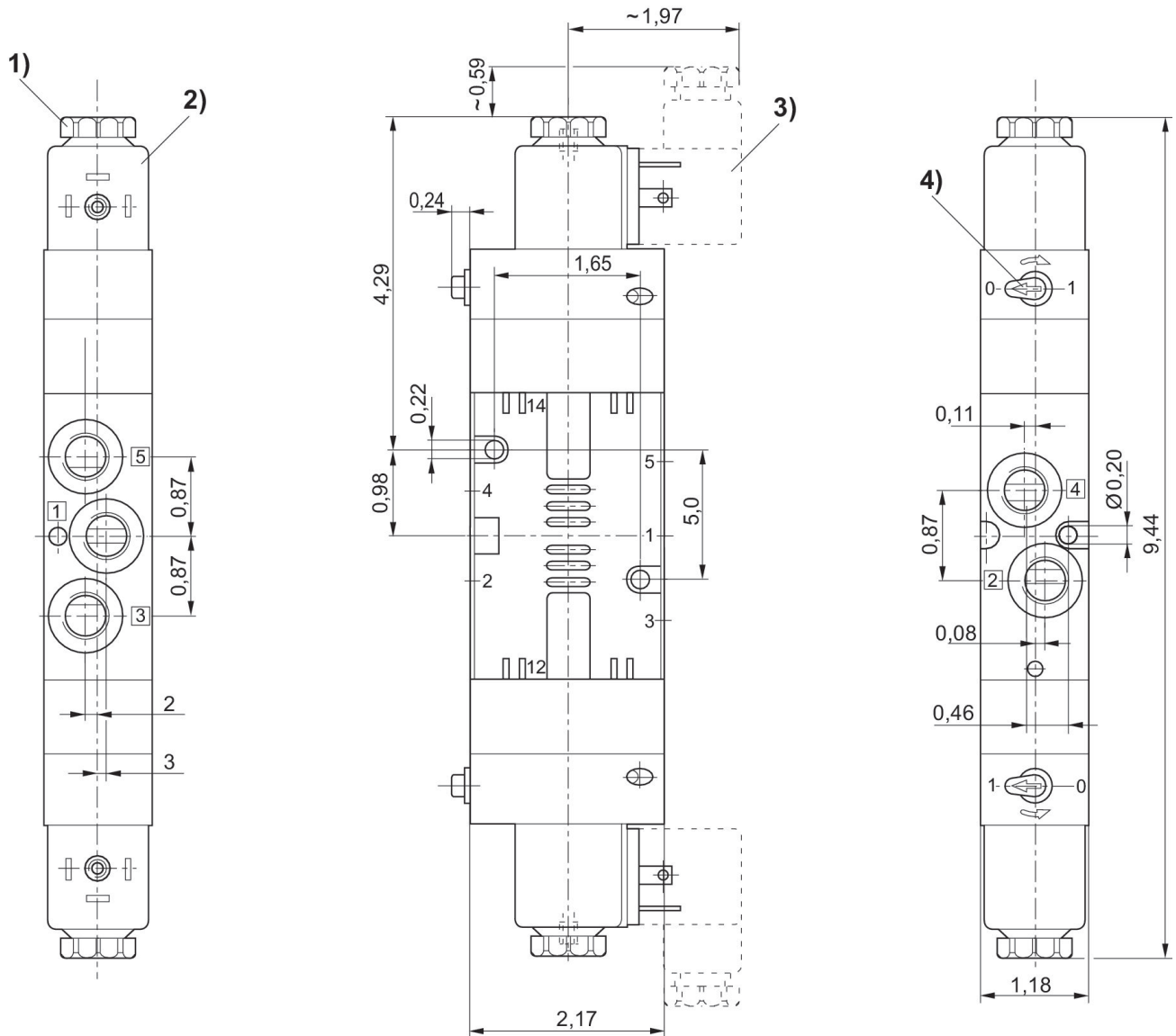

- 1) After removal of cap M5 internal thread 2) Coil can be plugged at 45° intervals 3) Valve plug connector
4) Manual override