

5/2-directional valve, Series CD07-LT

R414011879

General series information Series CD07-LT

- AVENTICS series CD07-LT consists of various spool valves with an extremely durable aluminum housing. CD07-LT is designed to operate under extreme ambient temperatures from -40 °C to +70 °C and extended voltage tolerance from -30 % to +25 %. The CD07-LT series is ideal for applications in harsh environments and complies with international standards for railroad applications.

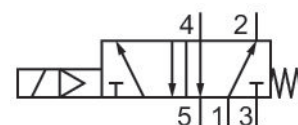

Technical data

Industry	Rail
Activation	Electrically
Frame size	CD07-LT
Valve type	Spool valve, positive overlapping
Switching principle	5/2, with spring return
Valve function	NC
Actuating control	Single Solenoid
Sealing principle	soft seal
Connection type	Pipe connection
Manual override	without
Compressed air connection	flange
Compressed air connection input	flange
Compressed air connection output	flange
Compressed air connection, exhaust	flange

Nominal flow Qn	1000 l/min
Nominal flow Qn 1 to 2	1000 l/min
Nominal flow Qn 2 to 3	1000 l/min
Working pressure min.	3 bar
Working pressure max	10 bar
Control pressure min.	3 bar
Control pressure max.	10 bar
Electrical connection type	Plug
Electrical connection size	EN 175301-803, form A
Electrical connection number of poles	3-pin
Connector standard	EN 175301-803:2006
Protection class with connection	IP65
Reverse polarity protection	Protected against polarity reversal
Operational voltage	110 V DC
DC operating voltage	110 V
Voltage tolerance DC	-30% / +25%
Pilot	Internal
Pilot valve width	30 mm
Power consumption DC	6 W
Duty cycle	100 %
Typ. switch-on time	110 ms
Typ. switch-off time	110 ms
Min. ambient temperature	-40 °C
Max. ambient temperature	70 °C
Min. medium temperature	-40 °C
Max. medium temperature	70 °C
Medium	Compressed air
Oil content of compressed air min.	0 mg/m ³
Oil content of compressed air max.	1 mg/m ³
Max. particle size	50 µm
Weight	0.824 kg

Material

Housing material	Aluminum, anodized Polyamide fiber-glass reinforced
Material Coil	Stainless Steel Polyamide
Seal material	Hydrogenated nitrile butadiene rubber Polyurethane Silicon
Part No.	R414011879

Technical information

Nominal flow Q_n at 6 bar and $\Delta p = 1$ bar

Pilot valve mounting on the side

The min. control pressure must be adhered to, since otherwise faulty switching and valve failure may result!

The pressure dew point must be at least 15 °C less than ambient and medium temperature and may not exceed 3 °C.

The oil content of compressed air must remain constant during the life cycle.

Use only the approved oils from AVENTICS. Further information can be found in the "Technical information" document (available in <https://www.emerson.com/en-us/support>).

The protection class is only ensured when the plug is mounted properly. For detailed information, see operating instructions.

Dimensions in mm

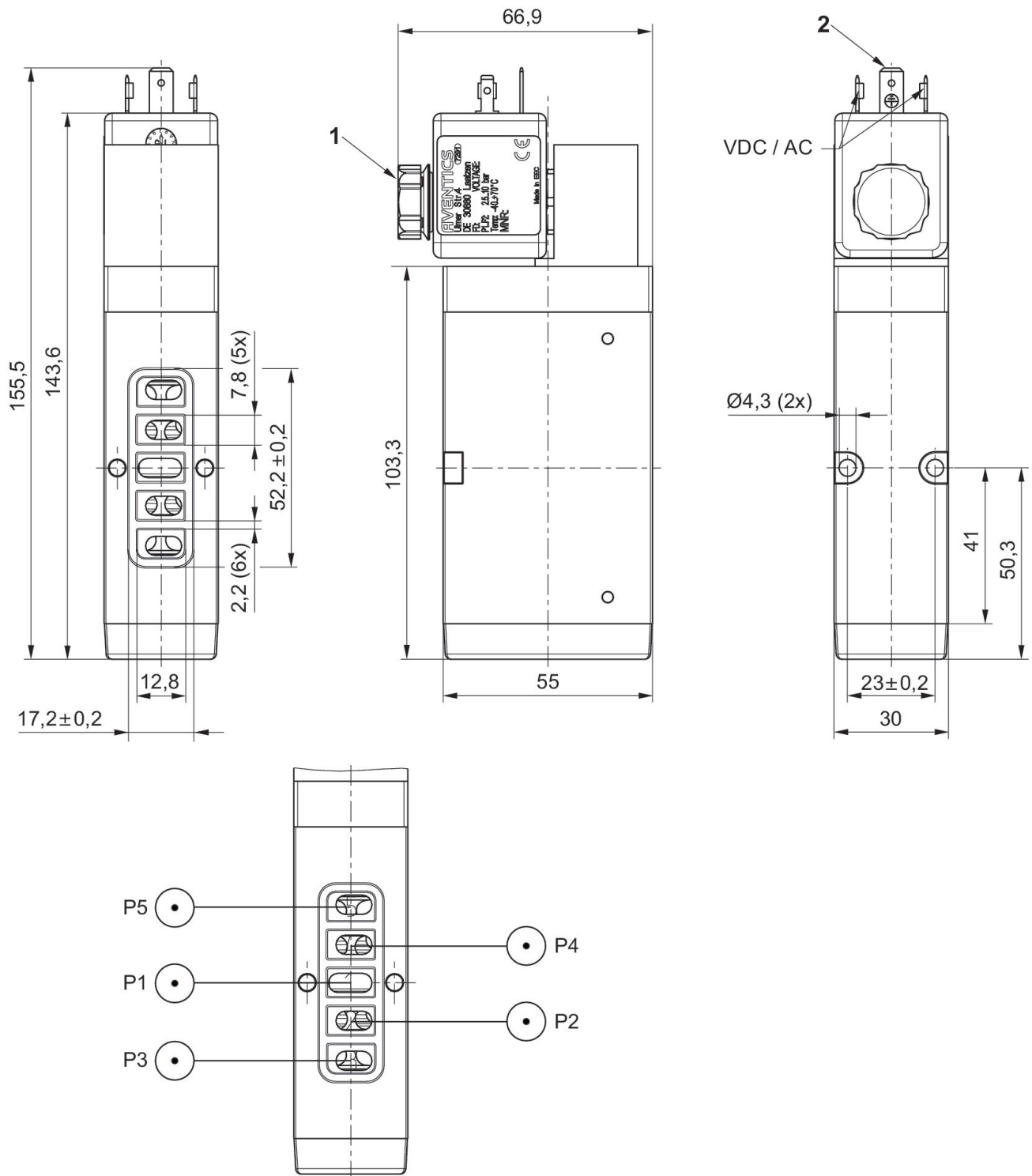

- 1) Silencer
2) Valve plug connector form A, EN 175301-803