

5/2-directional valve, Series CD12-LT

R414012772

General series information Series CD12-LT

- AVENTICS series CD12-LT consists of various spool valves with an extremely durable aluminum housing. CD12-LT is designed to operate under extreme ambient temperatures from -40 °C to +70 °C and extended voltage tolerance from -30 % to +25 %. The CD12-LT series is ideal for applications in harsh environments and complies with international standards for railroad applications.

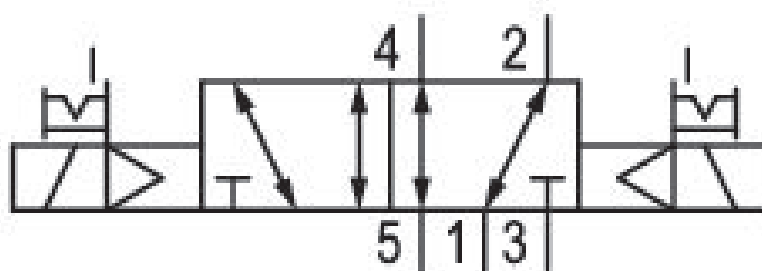

Technical data

Industry	Rail
Activation	Electrically
Valve type	Spool valve, positive overlapping
Switching principle	5/2, double solenoid
Valve function	NC
Actuating control	Double Solenoid
Sealing principle	soft seal
Connection type	Pipe connection
Manual override	with detent
Compressed air connection input	G 1/2
Compressed air connection output	G 1/2

Compressed air connection, exhaust	G 1/2
Nominal flow Qn 1 to 2	4000 l/min
Nominal flow Qn 2 to 3	4000 l/min
Working pressure min.	3 bar
Working pressure max	10 bar
Control pressure min.	3 bar
Control pressure max.	10 bar
Electrical connection type	Plug
Electrical connection size	EN 175301-803, form A
Electrical connection number of poles	3-pin
Connector standard	EN 175301-803:2006
Protection class with connection	IP65
Reverse polarity protection	Protected against polarity reversal
Operational voltage	24 V DC
Voltage tolerance DC	-30% / +25%
Pilot	Internal
Pilot valve width	30 mm
Power consumption DC	5.5 W
Duty cycle	100 %
Typ. switch-on time	80 ms
Typ. switch-off time	200 ms
Min. ambient temperature	-40 °C
Max. ambient temperature	70 °C
Min. medium temperature	-40 °C
Max. medium temperature	70 °C
Medium	Compressed air
Oil content of compressed air min.	0 mg/m ³
Oil content of compressed air max.	1 mg/m ³
Max. particle size	50 µm
Weight	1.5 kg

Material

Housing material	Aluminum, anodized Polyamide fiber-glass reinforced
Material Coil	Steel, chrome-plated Polyamide
Seal material	Hydrogenated nitrile butadiene rubber Polyurethane Silicone caoutchouc
Part No.	R414012772

Technical information

Nominal flow Q_n at 6 bar and $\Delta p = 1$ bar

Typ. switch-on/-off time at 20 °C

The min. control pressure must be adhered to, since otherwise faulty switching and valve failure may result!

The pressure dew point must be at least 15 °C less than ambient and medium temperature and may not exceed 3 °C.

The oil content of compressed air must remain constant during the life cycle.

Use only the approved oils from AVENTICS. Further information can be found in the "Technical information" document (available in <https://www.emerson.com/en-us/support>).

The protection class is only ensured when the plug is mounted properly. For detailed information, see operating instructions.

Dimensions in mm

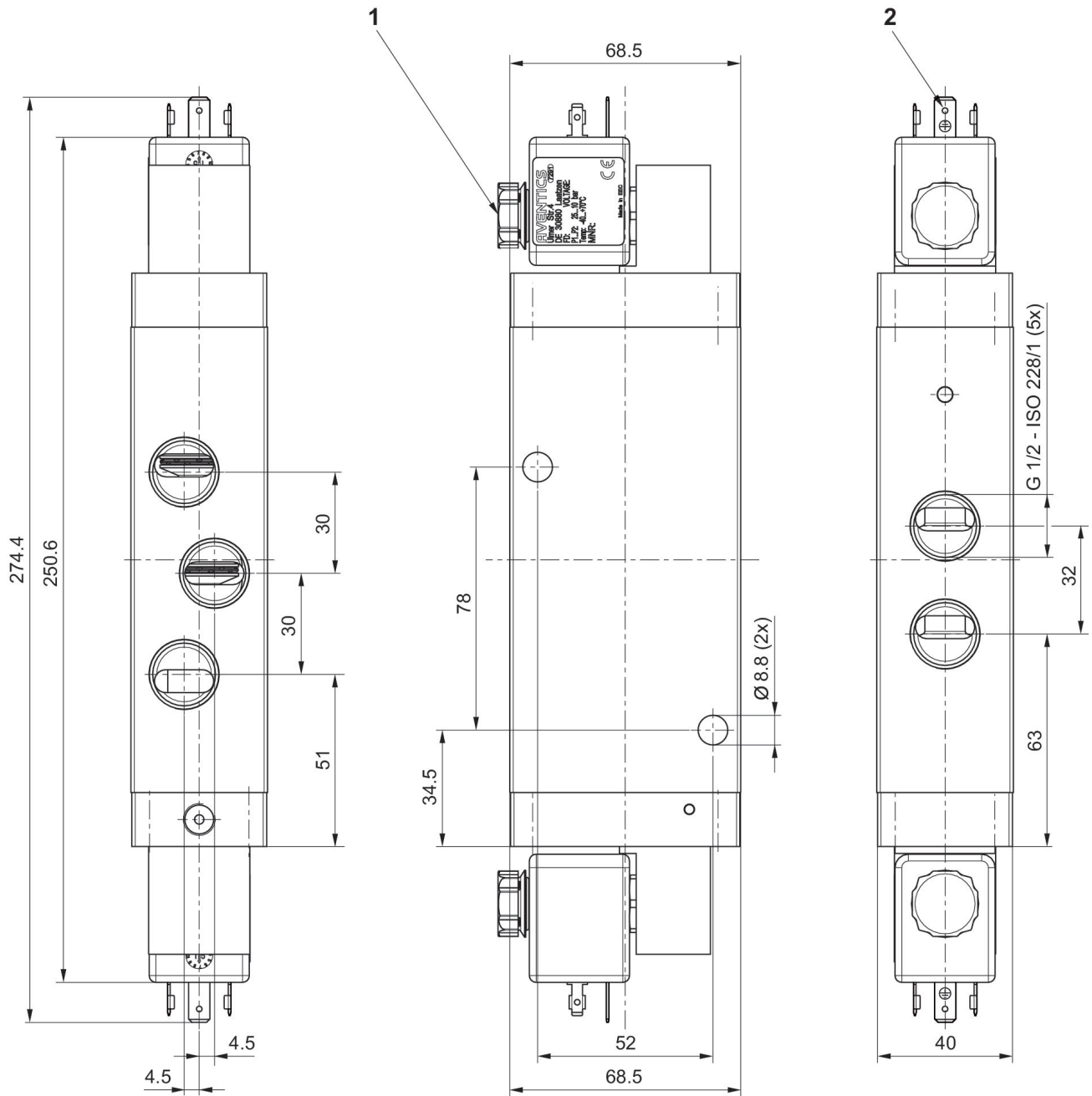

- 1) Silencer
- 2) plug, form A