

- Qn max. 7500 l/min

AVENTICS Series CERAM Directional valves

ISO 5599-1, size 1- 4, Series CERAM™

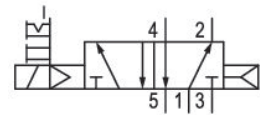

Technical data

Industry	Industrial
Activation	Electrically
Frame size	ISO 4
Switching principle	5/2, with air spring return
Actuating control	Single Solenoid
Sealing principle	Ceramic
Connection type	Plate connection
Manual override	with detent without detent
Standard compressed air connection	according to ISO 5599-1
Compressed air connection pilot exhaust	Base plate ISO 5599-1
Nominal flow Qn	7500 l/min
Min. working pressure	0 bar
Max. working pressure	10.3 bar
Min. control pressure	2.5 bar
Max. control pressure	10.3 bar

5/2-directional valve, Series CERAM™, size 4

CERAM™

R432006327

2023-10-25

Electrical connection type	Plug
Electrical connection size	EN 175301-803, form A
Protection class according to NEMA	NEMA 4
Operational voltage	24 V DC
Operational voltage DC	24 V
Voltage tolerance DC	-10% / +10%
Pilot	Internal
Coil width	30 mm
Pilot valve width	30 mm CNOMO
Power consumption DC	2.7 W
Blocking principle	Single base plate principle
Can be assembled into blocks	Can be assembled into blocks
Valve plug connector	Without valve plug connector
Standards	ISO 5599-1
Min. ambient temperature	-15 °C
Max. ambient temperature	66 °C
Min. medium temperature	-15 °C
Max. medium temperature	66 °C
Medium	Compressed air
Mounting screws	M8 with hexagon socket
Mounting screw tightening torque	9.2 Nm
Weight	2.45 kg
Material	
Housing material	Die cast zinc
Surface housing	painted gray
Part No.	R432006327

Technical information

The min. control pressure must be adhered to, since otherwise faulty switching and valve failure may result!

The pressure dew point must be at least 15 °C less than ambient and medium temperature and may not exceed 3 °C.

The oil content of compressed air must remain constant during the life cycle.

Use only the approved oils from AVENTICS. Further information can be found in the “Technical information” document (available in <https://www.emerson.com/en-us/support>).

Dimensions in inches

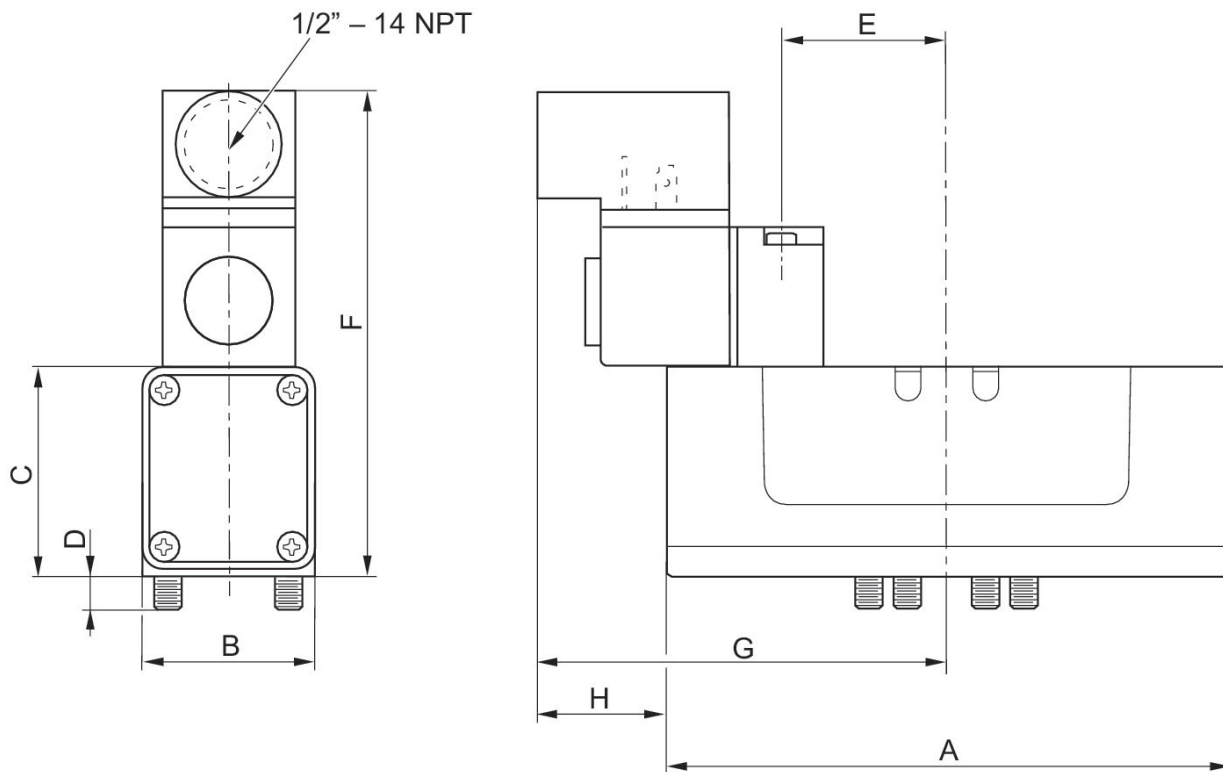

Dimensions in inches

Part No.	A	B	C	D	E	F	G	H
R432030378	8.62	3.09	2.89	0.41	1.62	5.23	6.65	0.68
R432006327	8.62	3.09	2.89	0.41	1.62	5.23	6.65	0.68
R432030352	8.62	3.09	2.89	0.41	1.62	5.23	6.65	0.68
R432006322	8.62	3.09	2.89	0.41	1.62	5.23	6.65	0.68
R432006324	8.62	3.09	2.89	0.41	1.62	5.23	6.65	0.68
R432002468	8.62	3.09	2.89	0.41	1.62	5.23	6.65	0.68

5/2-directional valve, Series CERAM™, size 4

R432006327

CERAM™

2023-10-25

Part No.	A	B	C	D	E	F	G	H
repeat-Column								