

AVENTICS Guide units

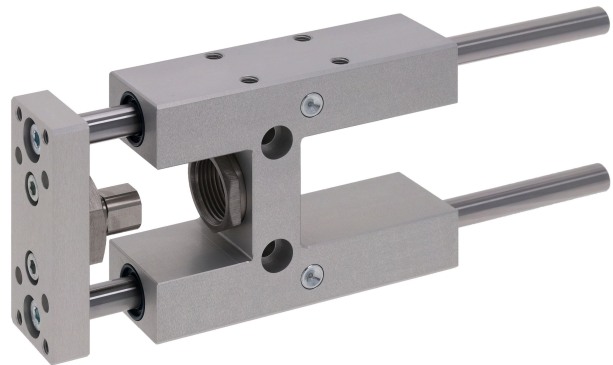

Technical data

Industry	Industrial
Piston Ø	20 mm
Stroke	600 mm
Bearing type	Linear ball bearing
For standard cylinders	ISO 6432
Min. ambient temperature	-20 °C
Max. ambient temperature	80 °C
Weight 0 mm stroke	0.73 kg
Weight +10 mm stroke	0.012 kg

Material

Bearing housings	Aluminum
Surface bearing housing	colorless anodized
Bearing type	Steel, chrome-plated
Carrying plate	Aluminum
Surface carrying plate	colorless anodized
Material flexible coupling in carrying plate	Stainless Steel
Material guide rods	Hardened heat-treated steel
Part No.	0821401304

Technical information

Guide units for cylinder \varnothing 12 also fit on cylinder \varnothing 16

Dimensions

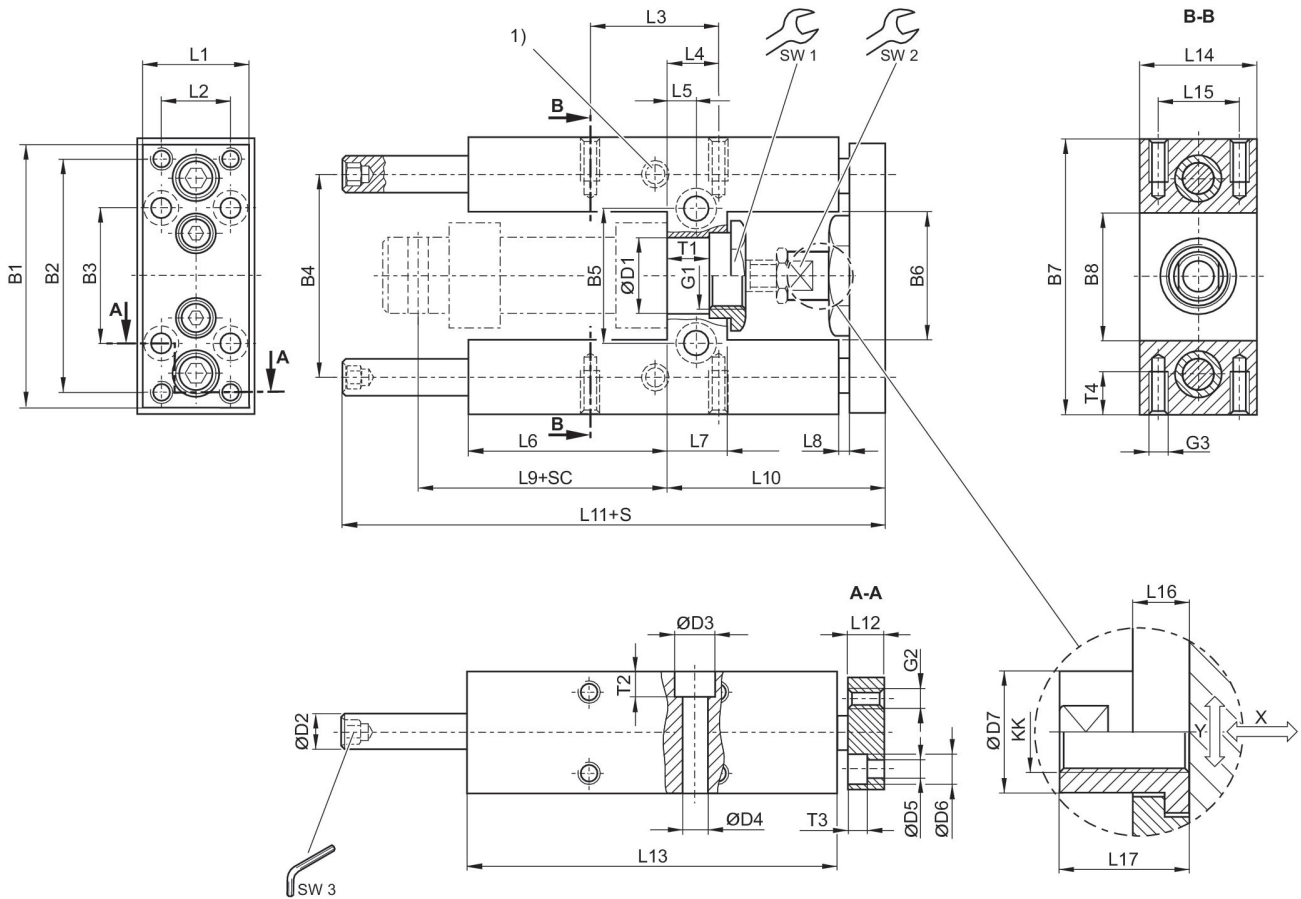

- 1) Lube nipple
- S = stroke
- SC = cylinder stroke
- X = max. play (axial)
- Y = min. play (radial)
- Hexagon in guide rod

Piston \varnothing	Part No.	B1	B2	B3	B4	B5	B6	B7	B8
12	0821401395	63	54	32	46	24	27	65	27
20	0821401300	76	68	40	58	38	37	79	37
25	0821401310	76	68	40	58	38	37	79	37

Piston \varnothing	D1	D2	D3	D4	D5	D6	D7	G1	G2
12	16 H7	8	-	5.5	4.5	8	10	M16x1,5	M4
20	22 H7	10	11	6.6	5.5	10.5	14.5	M22x1,5	M5

Piston Ø	D1	D2	D3	D4	D5	D6	D7	G1	G2
25	22 H7	10	11	6.6	5.5	10.5	14.5	M22x1,5	M5

Piston Ø	G3	KK	L1	L2	L3	L4	L5	L6	L7
12	M4	M6	27	15	32.5	11	6.5	37	13
20	M6	M8	32	20	32.5	15	8.5	58	17
25	M6	M10x1,25	32	20	32.5	15	8.5	58	17

Piston Ø	L8	L9	L10	L11	L12	L13	L14	L15	L16
12	3	52.6	51	133	10	75	30	22	7
20	3	71	65	160.5	12	108	34	23	6
25	3	76	65	160.5	12	108	34	23	6

Piston Ø	L17	SW1	SW2	SW3	T1	T2	T3	T4
12	18	19	8	4	10.6	–	4.6	8
20	22	27	13	5	11	7	5.7	14
25	17	27	13	5	11	7	5.7	14

Useful load

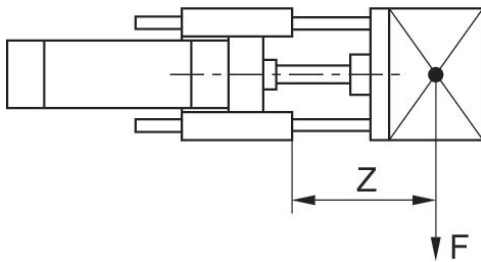

F = Useful load, Z = Projection

Bending due to 10 N load

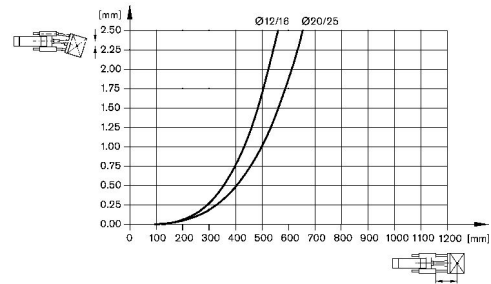

Bending due to own load

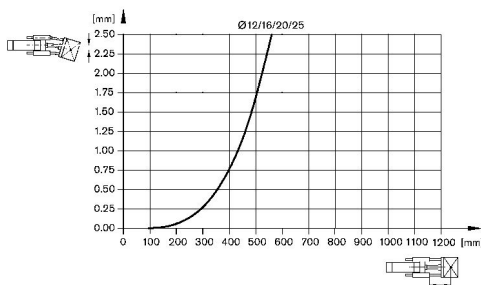

Useful load

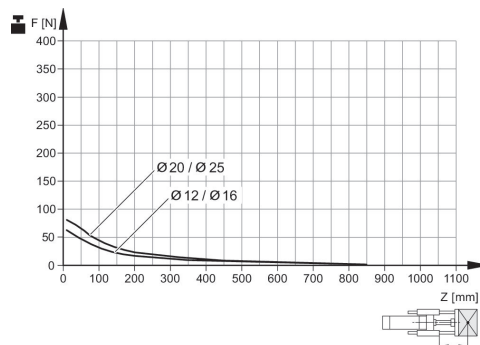

Service life 5×10^6 m
F = Useful load, Z = Projection